









Data .....



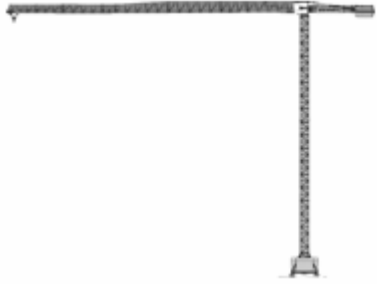

Nume, prenume candidat .....

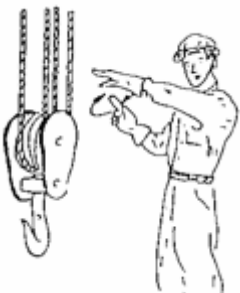

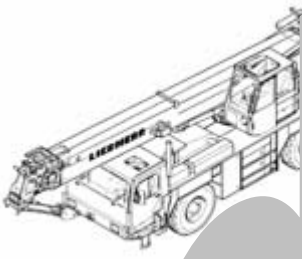

Locul desfasurarii testarii .....

**LUCRARE SCRISA PENTRU EXAMINARE MACARAGII**

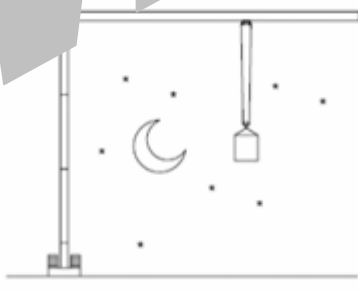
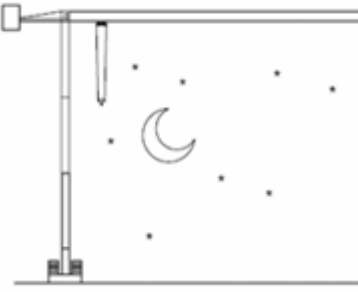
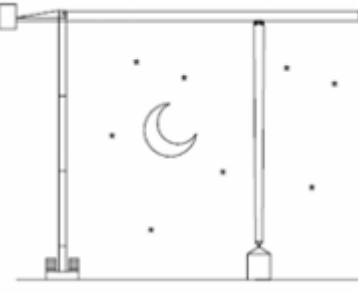
Nr. crt.	TEST GRILA NR. 2		
1	Care chinga nu este o chinga de ridicare sarcini?		
			
		b) <input type="checkbox"/>	<input type="checkbox"/>
	Care dintre acestea poate fi utilizata pentru macaraga cu autorizatie grupa B?		
			
	a) <input type="checkbox"/>	b) <input type="checkbox"/>	c) <input type="checkbox"/>
	Care semnal reprezinta comanda de „OPRESTE” in codul de semnalizare?		
3			
	a) <input type="checkbox"/>	b) <input type="checkbox"/>	c) <input type="checkbox"/>

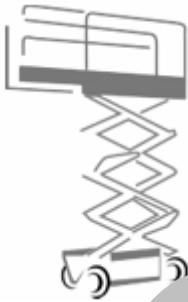

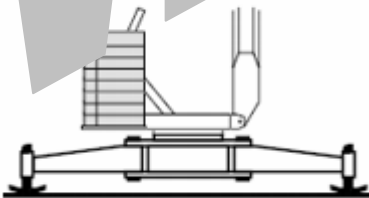
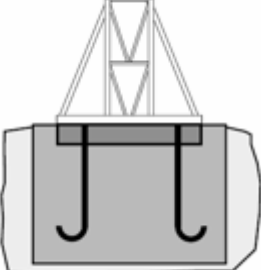
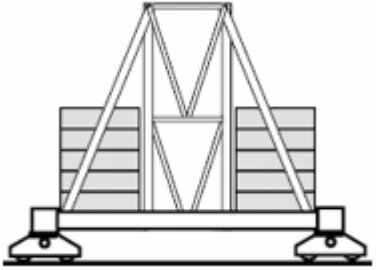

Nr. crt.	TEST GRILA NR. 2		
4	<b>Care instalatie de ridicat nu necesita obligatoriu utilizarea legatorilor de sarcina?</b>		
			
	a) <input type="checkbox"/>	b) <input type="checkbox"/>	c) <input type="checkbox"/>
	<b>Care dintre cele urmatoare sunt componente ale sistemului de iluminare?</b>		
			
	a) <input type="checkbox"/>	b) <input type="checkbox"/>	c) <input type="checkbox"/>
6	<b>Pe care dintre cele de mai jos se lasata corect de catre macaragiu in timpul nefunctionarii?</b>		
			
	a) <input type="checkbox"/>	b) <input type="checkbox"/>	c) <input type="checkbox"/>

Nr. crt.	TEST GRILA NR. 2		
7	<b>Care instalatie de ridicat necesita obligatoriu utilizarea legatorilor de sarcina?</b>		
			
	a) <input type="checkbox"/>	b) <input type="checkbox"/>	c) <input type="checkbox"/>
	<b>Care carlig de sarcina poate fi utilizat in constructiile de secunda?</b>		
			
	a) <input type="checkbox"/>	b) <input type="checkbox"/>	c) <input type="checkbox"/>
	<b>Care tip de gura de ridicare este montata cu ancoraj in fundatie?</b>		
			
	a) <input type="checkbox"/>	b) <input type="checkbox"/>	c) <input type="checkbox"/>

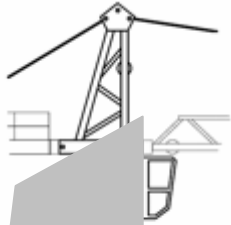

SC ASISCO TEHNIC SRL  
str. Pietrele Doamnei nr. 25, cod postal 060317, sector 6, Bucuresti  
telefon: 031 – 1043756  
mobil: 0753 – 012324  
e-mail: office@asisco.ro  
http://www.asisco.ro

Nr. crt.	TEST GRILA NR.		
10	In care imagine este reprezentat un contrabrat al unei crane de tip		
			
		b) <input type="checkbox"/>	c) <input type="checkbox"/>

.....  
em ..... co ..... de exa .....  
.....  
SPINS ..... MIS

.....  
(semnatura persoana examinata)