

# EVALUARE RISCURI STIVUITOR TELESCOPIC GENIE GTH-3512

# Genie®



Capacitate maxima de  
ridicare:

3500 kg



Inaltime maxima de lucru:



12,05 m

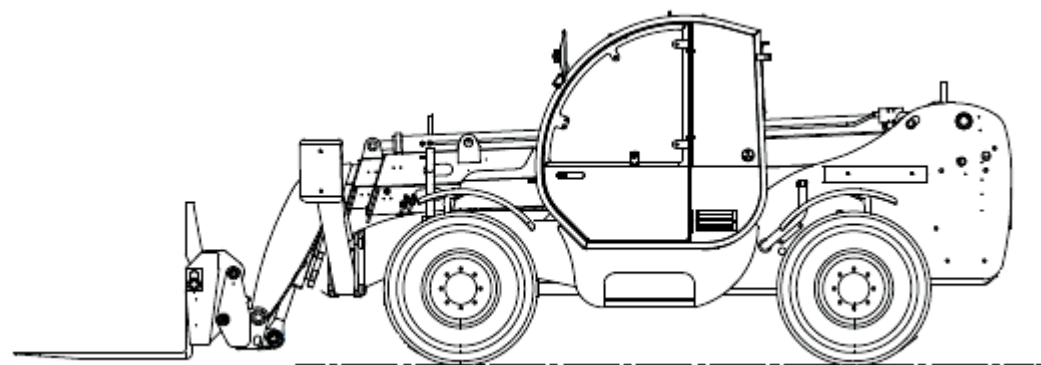

Raza maxima de lucru:



8,59 m







1	<p><b>Pericol identificat:</b></p> <p><b>Persoane care pot fi ranite sau care pot rani alte persoane atunci cand stivuitorul este manevrat de catre personal neautorizat.</b></p> <p>Exista un risc? DA <input checked="" type="checkbox"/> NU <input type="checkbox"/></p> <p>Nivel risc:</p> <p> <b>RIDICAT</b></p>	<p><b>In cazul in care exista un risc, masurile propuse a fi puse in aplicare sunt:</b></p> <p>Persoana care manevreaza acest stivuitor trebuie sa fie instruita, calificata si autorizata sa lucreze cu acest utilaj. Autorizarea manevrantului se va face in conformitate cu cerintele ISCIR in vigoare.</p> <p>Stivuitorul este obligat sa citeasca si sa-si insuseasca toate instructiunile din manualul producatorului stivuitorului inainte de a incepe sa lucreze cu acesta.</p> <p>Exista un control a riscurilor posibile? DA <input checked="" type="checkbox"/> NU <input checked="" type="checkbox"/></p> <p><b>Cand trebuie puse in aplicare masurile de control a riscurilor?</b></p> <p>Inainte de utilizarea stivuitorului.</p>
2	<p><b>Pericol identificat:</b></p> <p><b>Persoane care pot fi ranite sau care pot rani alte persoane atunci cand stivuitorul este utilizat in exploatare fara personal autorizat de supraveghere.</b></p> <p>Exista un risc? DA <input checked="" type="checkbox"/> NU <input type="checkbox"/></p> <p>Nivel risc:</p> <p> <b>RIDICAT</b></p>	<p><b>In cazul in care exista un risc, masurile propuse a fi puse in aplicare sunt:</b></p> <p>Utilizatorul este obligat, in conformitate cu legislatia nationala in vigoare, sa aiba un operator RSVTI propriu care sa-i asigure supravegherea si verificarea tehnica a instalatiilor de ridicat aflate in exploatare.</p> <p>Este strict interzisa utilizarea stivuitorului in cazul in care nu exista operator RSVTI.</p> <p>Exista un control a riscurilor posibile? DA <input checked="" type="checkbox"/> NU <input type="checkbox"/></p> <p><b>Cand trebuie puse in aplicare masurile de control a riscurilor?</b></p> <p>Inainte de utilizarea stivuitorului.</p>



<p>3</p>	<p><b>Pericol identificat:</b></p> <p style="text-align: right;"><b>In cazul in care exista un risc, masurile propuse a fi puse in aplicare sunt:</b></p> <p>Exista un risc? DA <input checked="" type="checkbox"/> NU <input type="checkbox"/>      Exista un control a riscurilor posibile? DA <input checked="" type="checkbox"/> NU <input type="checkbox"/></p> <p>Nivel risc:</p> <p> <b>RIDICAT</b></p> <p><b>Cand trebuie puse in aplicare masurile de control a riscurilor?</b> Inainte de utilizarea stivuitorului.</p>
<p>4</p>	<p><b>Pericol identificat:</b></p> <p style="text-align: right;"><b>In cazul in care exista un risc, masurile propuse a fi puse in aplicare sunt:</b></p> <p>Exista un risc? DA <input checked="" type="checkbox"/> NU <input type="checkbox"/>      Exista un control a riscurilor posibile? DA <input checked="" type="checkbox"/> NU <input type="checkbox"/></p> <p>Nivel risc:</p> <p> <b>RIDICAT</b></p> <p><b>Cand trebuie puse in aplicare masurile de control a riscurilor?</b> Inainte de utilizarea stivuitorului.</p>

5	<p><b>Pericol identificat:</b></p> <p><b>In cazul in care exista un risc, masurile propuse a fi puse in aplicare sunt:</b></p> <p>Exista un risc? DA <input checked="" type="checkbox"/> NU <input type="checkbox"/> Exista un control a riscurilor posibile? DA <input checked="" type="checkbox"/> NU <input type="checkbox"/></p> <p>Nivel risc:</p> <p> <b>RIDICAT</b></p> <p><b>Cand trebuie puse in aplicare masurile de control a riscurilor?</b> Inainte de utilizarea stivuitorului.</p>
6	<p><b>Pericol identificat:</b></p> <p><b>In cazul in care exista un risc, masurile propuse a fi puse in aplicare sunt:</b></p> <p>Exista un risc? DA <input type="checkbox"/> NU <input checked="" type="checkbox"/> Exista un control a riscurilor posibile? DA <input checked="" type="checkbox"/> NU <input type="checkbox"/></p> <p>Nivel risc:</p> <p> <b>SCAZUT</b></p> <p><b>Cand trebuie puse in aplicare masurile de control a riscurilor?</b> Inainte de utilizarea stivuitorului.</p>



7	<p><b>Pericol identificat:</b></p> <p><b>In cazul in care exista un risc, masurile propuse a fi puse in aplicare sunt:</b></p> <p>Exista un risc? DA <input checked="" type="checkbox"/> NU <input type="checkbox"/> Exista un control a riscurilor posibile? DA <input checked="" type="checkbox"/> NU <input type="checkbox"/></p> <p>Nivel risc:</p> <p> <b>RIDICAT</b></p> <p><b>Cand trebuie puse in aplicare masurile de control a riscurilor?</b> Inainte de utilizarea stivuitorului.</p>
8	<p><b>Pericol identificat:</b></p> <p><b>In cazul in care exista un risc, masurile propuse a fi puse in aplicare sunt:</b></p> <p>Exista un risc? DA <input checked="" type="checkbox"/> NU <input type="checkbox"/> Exista un control a riscurilor posibile? DA <input checked="" type="checkbox"/> NU <input type="checkbox"/></p> <p>Nivel risc:</p> <p> <b>RIDICAT</b></p> <p><b>Cand trebuie puse in aplicare masurile de control a riscurilor?</b> Inainte de utilizarea stivuitorului.</p>



9	<p><b>Pericol identificat:</b></p> <p><b>In cazul in care exista un risc, masurile propuse a fi puse in aplicare sunt:</b></p> <p>Exista un risc? DA <input checked="" type="checkbox"/> NU <input type="checkbox"/> Exista un control a riscurilor posibile? DA <input checked="" type="checkbox"/> NU <input type="checkbox"/></p> <p>Nivel risc:</p> <p> <b>RIDICAT</b></p> <p><b>Cand trebuie puse in aplicare masurile de control a riscurilor?</b> Inainte de utilizarea stivuiitorului.</p>
10	<p><b>Pericol identificat:</b></p> <p><b>In cazul in care exista un risc, masurile propuse a fi puse in aplicare sunt:</b></p> <p>Exista un risc? DA <input checked="" type="checkbox"/> NU <input type="checkbox"/> Exista un control a riscurilor posibile? DA <input checked="" type="checkbox"/> NU <input type="checkbox"/></p> <p>Nivel risc:</p> <p> <b>RIDICAT</b></p> <p><b>Cand trebuie puse in aplicare masurile de control a riscurilor?</b> Inainte de utilizarea stivuiitorului.</p>



11	<p><b>Pericol identificat:</b></p> <p><b>In cazul in care exista un risc, masurile propuse a fi puse in aplicare sunt:</b></p> <p>Exista un risc? DA <input checked="" type="checkbox"/> NU <input type="checkbox"/> Exista un control a riscurilor posibile? DA <input checked="" type="checkbox"/> NU <input type="checkbox"/></p> <p>Nivel risc:</p> <p> <b>RIDICAT</b></p> <p><b>Cand trebuie puse in aplicare masurile de control a riscurilor?</b> Inainte de utilizarea stivuitorului.</p>
12	<p><b>Pericol identificat:</b></p> <p><b>In cazul in care exista un risc, masurile propuse a fi puse in aplicare sunt:</b></p> <p>Exista un risc? DA <input type="checkbox"/> NU <input checked="" type="checkbox"/> Exista un control a riscurilor posibile? DA <input checked="" type="checkbox"/> NU <input type="checkbox"/></p> <p>Nivel risc:</p> <p> <b>SCAZUT</b></p> <p><b>Cand trebuie puse in aplicare masurile de control a riscurilor?</b> Inainte de utilizarea stivuitorului.</p>



13	<p><b>Pericol identificat:</b></p> <p><b>In cazul in care exista un risc, masurile propuse a fi puse in aplicare sunt:</b></p> <p>Exista un risc? DA <input checked="" type="checkbox"/> NU <input type="checkbox"/> Exista un control a riscurilor posibile? DA <input checked="" type="checkbox"/> NU <input type="checkbox"/></p> <p>Nivel risc:</p> <p> <b>RIDICAT</b></p> <p><b>Cand trebuie puse in aplicare masurile de control a riscurilor?</b> Inainte de utilizarea stivuitorului.</p>
14	<p><b>Pericol identificat:</b></p> <p><b>In cazul in care exista un risc, masurile propuse a fi puse in aplicare sunt:</b></p> <p>Exista un risc? DA <input checked="" type="checkbox"/> NU <input type="checkbox"/> Exista un control a riscurilor posibile? DA <input checked="" type="checkbox"/> NU <input type="checkbox"/></p> <p>Nivel risc:</p> <p> <b>RIDICAT</b></p> <p><b>Cand trebuie puse in aplicare masurile de control a riscurilor?</b> Inainte de utilizarea stivuitorului.</p>







15	<p><b>Pericol identificat:</b></p> <p><b>In cazul in care exista un risc, masurile propuse a fi puse in aplicare sunt:</b></p> <p>Exista un risc? DA <input checked="" type="checkbox"/> NU <input type="checkbox"/> Exista un control a riscurilor posibile? DA <input checked="" type="checkbox"/> NU <input type="checkbox"/></p> <p>Nivel risc:</p> <p> <b>MEDIU</b></p> <p><b>Cand trebuie puse in aplicare masurile de control a riscurilor?</b> Inainte de utilizarea stivuitorului.</p>
16	<p><b>Pericol identificat:</b></p> <p><b>In cazul in care exista un risc, masurile propuse a fi puse in aplicare sunt:</b></p> <p>Exista un risc? DA <input checked="" type="checkbox"/> NU <input type="checkbox"/> Exista un control a riscurilor posibile? DA <input checked="" type="checkbox"/> NU <input type="checkbox"/></p> <p>Nivel risc:</p> <p> <b>RIDICAT</b></p> <p><b>Cand trebuie puse in aplicare masurile de control a riscurilor?</b> Inainte de utilizarea stivuitorului.</p>



17	<p><b>Pericol identificat:</b></p> <p><b>In cazul in care exista un risc, masurile propuse a fi puse in aplicare sunt:</b></p> <p>Exista un risc? DA <input checked="" type="checkbox"/> NU <input type="checkbox"/> Exista un control a riscurilor posibile? DA <input checked="" type="checkbox"/> NU <input type="checkbox"/></p> <p>Nivel risc:</p> <p> <b>RIDICAT</b></p> <p><b>Cand trebuie puse in aplicare masurile de control a riscurilor?</b> Inainte de utilizarea stivuitorului.</p>
18	<p><b>Pericol identificat:</b></p> <p><b>In cazul in care exista un risc, masurile propuse a fi puse in aplicare sunt:</b></p> <p>Exista un risc? DA <input checked="" type="checkbox"/> NU <input type="checkbox"/> Exista un control a riscurilor posibile? DA <input checked="" type="checkbox"/> NU <input type="checkbox"/></p> <p>Nivel risc:</p> <p> <b>RIDICAT</b></p> <p><b>Cand trebuie puse in aplicare masurile de control a riscurilor?</b> Inainte de utilizarea stivuitorului.</p>



19	<p><b>Pericol identificat:</b></p> <p>Exista un risc? DA <input type="checkbox"/> NU <input checked="" type="checkbox"/></p> <p>Nivel risc:   SCAZUT</p>	<p><b>In cazul in care exista un risc, masurile propuse a fi puse in aplicare sunt:</b></p> <p>Exista un control a riscurilor posibile? DA <input checked="" type="checkbox"/> NU <input type="checkbox"/></p> <p><b>Cand trebuie puse in aplicare masurile de control a riscurilor?</b> Inainte de utilizarea stivuitorului.</p>
20	<p><b>Pericol identificat:</b></p> <p>Exista un risc? DA <input checked="" type="checkbox"/> NU <input type="checkbox"/></p> <p>Nivel risc:   RIDICAT</p>	<p><b>In cazul in care exista un risc, masurile propuse a fi puse in aplicare sunt:</b></p> <p>Exista un control a riscurilor posibile? DA <input checked="" type="checkbox"/> NU <input type="checkbox"/></p> <p><b>Cand trebuie puse in aplicare masurile de control a riscurilor?</b> Inainte de utilizarea stivuitorului.</p>

21	<p><b>Pericol identificat:</b></p> <p><b>In cazul in care exista un risc, masurile propuse a fi puse in aplicare sunt:</b></p> <p>Exista un risc? DA <input checked="" type="checkbox"/> NU <input type="checkbox"/> Exista un control a riscurilor posibile? DA <input checked="" type="checkbox"/> NU <input type="checkbox"/></p> <p>Nivel risc:</p> <p> <b>RIDICAT</b></p> <p><b>Cand trebuie puse in aplicare masurile de control a riscurilor?</b> Inainte de utilizarea stivuitorului.</p>
22	<p><b>Pericol identificat:</b></p> <p><b>In cazul in care exista un risc, masurile propuse a fi puse in aplicare sunt:</b></p> <p>Exista un risc? DA <input type="checkbox"/> NU <input checked="" type="checkbox"/> Exista un control a riscurilor posibile? DA <input checked="" type="checkbox"/> NU <input type="checkbox"/></p> <p>Nivel risc:</p> <p> <b>SCAZUT</b></p> <p><b>Cand trebuie puse in aplicare masurile de control a riscurilor?</b> Inainte de utilizarea stivuitorului.</p>



23	<p><b>Pericol identificat:</b></p> <p><b>In cazul in care exista un risc, masurile propuse a fi puse in aplicare sunt:</b></p> <p>Exista un risc? DA <input type="checkbox"/> NU <input checked="" type="checkbox"/> Exista un control a riscurilor posibile? DA <input checked="" type="checkbox"/> NU <input type="checkbox"/></p> <p>Nivel risc:</p> <p> <b>SCAZUT</b></p> <p><b>Cand trebuie puse in aplicare masurile de control a riscurilor?</b> Inainte de utilizarea stivuitorului.</p>
24	<p><b>Pericol identificat:</b></p> <p><b>In cazul in care exista un risc, masurile propuse a fi puse in aplicare sunt:</b></p> <p>Exista un risc? DA <input checked="" type="checkbox"/> NU <input type="checkbox"/> Exista un control a riscurilor posibile? DA <input checked="" type="checkbox"/> NU <input type="checkbox"/></p> <p>Nivel risc:</p> <p> <b>RIDICAT</b></p> <p><b>Cand trebuie puse in aplicare masurile de control a riscurilor?</b> Inainte de utilizarea stivuitorului.</p>



25	<p><b>Pericol identificat:</b></p> <p><b>In cazul in care exista un risc, masurile propuse a fi puse in aplicare sunt:</b></p> <p>Exista un risc? DA <input checked="" type="checkbox"/> NU <input type="checkbox"/> Exista un control a riscurilor posibile? DA <input checked="" type="checkbox"/> NU <input type="checkbox"/></p> <p>Nivel risc:</p> <p> <b>MEDIU</b></p> <p><b>Cand trebuie puse in aplicare masurile de control a riscurilor?</b> Inainte de utilizarea stivuitorului.</p>
26	<p><b>Pericol identificat:</b></p> <p><b>In cazul in care exista un risc, masurile propuse a fi puse in aplicare sunt:</b></p> <p>Exista un risc? DA <input checked="" type="checkbox"/> NU <input type="checkbox"/> Exista un control a riscurilor posibile? DA <input checked="" type="checkbox"/> NU <input type="checkbox"/></p> <p>Nivel risc:</p> <p> <b>MEDIU</b></p> <p><b>Cand trebuie puse in aplicare masurile de control a riscurilor?</b> Inainte de utilizarea stivuitorului.</p>



27	<p><b>Pericol identificat:</b></p> <p><b>In cazul in care exista un risc, masurile propuse a fi puse in aplicare sunt:</b></p> <p>Exista un risc? DA <input checked="" type="checkbox"/> NU <input type="checkbox"/> Exista un control a riscurilor posibile? DA <input checked="" type="checkbox"/> NU <input type="checkbox"/></p> <p>Nivel risc:</p> <p> <b>RIDICAT</b></p> <p><b>Cand trebuie puse in aplicare masurile de control a riscurilor?</b> Inainte de utilizarea stivuitorului.</p>
28	<p><b>Pericol identificat:</b></p> <p><b>In cazul in care exista un risc, masurile propuse a fi puse in aplicare sunt:</b></p> <p>Exista un risc? DA <input checked="" type="checkbox"/> NU <input type="checkbox"/> Exista un control a riscurilor posibile? DA <input checked="" type="checkbox"/> NU <input type="checkbox"/></p> <p>Nivel risc:</p> <p> <b>RIDICAT</b></p> <p><b>Cand trebuie puse in aplicare masurile de control a riscurilor?</b> Inainte de utilizarea stivuitorului.</p>



29	<p><b>Pericol identificat:</b></p> <p><b>In cazul in care exista un risc, masurile propuse a fi puse in aplicare sunt:</b></p> <p>Exista un risc? DA <input checked="" type="checkbox"/> NU <input type="checkbox"/> Exista un control a riscurilor posibile? DA <input checked="" type="checkbox"/> NU <input type="checkbox"/></p> <p>Nivel risc:</p> <p> <b>RIDICAT</b></p> <p><b>Cand trebuie puse in aplicare masurile de control a riscurilor?</b> Inainte de utilizarea stivuitorului.</p>
30	<p><b>Pericol identificat:</b></p> <p><b>In cazul in care exista un risc, masurile propuse a fi puse in aplicare sunt:</b></p> <p>Exista un risc? DA <input checked="" type="checkbox"/> NU <input type="checkbox"/> Exista un control a riscurilor posibile? DA <input checked="" type="checkbox"/> NU <input type="checkbox"/></p> <p>Nivel risc:</p> <p> <b>RIDICAT</b></p> <p><b>Cand trebuie puse in aplicare masurile de control a riscurilor?</b> Inainte de utilizarea stivuitorului.</p>







31	<p><b>Pericol identificat:</b></p> <p><b>In cazul in care exista un risc, masurile propuse a fi puse in aplicare sunt:</b></p> <p>Exista un risc? DA <input checked="" type="checkbox"/> NU <input type="checkbox"/> Exista un control a riscurilor posibile? DA <input checked="" type="checkbox"/> NU <input type="checkbox"/></p> <p>Nivel risc:</p> <p> <b>RIDICAT</b></p> <p><b>Cand trebuie puse in aplicare masurile de control a riscurilor?</b> Inainte de utilizarea stivuitorului.</p>
32	<p><b>Pericol identificat:</b></p> <p><b>In cazul in care exista un risc, masurile propuse a fi puse in aplicare sunt:</b></p> <p>Exista un risc? DA <input checked="" type="checkbox"/> NU <input type="checkbox"/> Exista un control a riscurilor posibile? DA <input checked="" type="checkbox"/> NU <input type="checkbox"/></p> <p>Nivel risc:</p> <p> <b>RIDICAT</b></p> <p><b>Cand trebuie puse in aplicare masurile de control a riscurilor?</b> Inainte de utilizarea stivuitorului.</p>



33	<p><b>Pericol identificat:</b></p> <p><b>In cazul in care exista un risc, masurile propuse a fi puse in aplicare sunt:</b></p> <p>Exista un risc? DA <input checked="" type="checkbox"/> NU <input type="checkbox"/> Exista un control a riscurilor posibile? DA <input checked="" type="checkbox"/> NU <input type="checkbox"/></p> <p>Nivel risc:</p> <p> <b>RIDICAT</b></p> <p><b>Cand trebuie puse in aplicare masurile de control a riscurilor?</b> Inainte de utilizarea stivuitorului.</p>
34	<p><b>Pericol identificat:</b></p> <p><b>In cazul in care exista un risc, masurile propuse a fi puse in aplicare sunt:</b></p> <p>Exista un risc? DA <input checked="" type="checkbox"/> NU <input type="checkbox"/> Exista un control a riscurilor posibile? DA <input checked="" type="checkbox"/> NU <input type="checkbox"/></p> <p>Nivel risc:</p> <p> <b>RIDICAT</b></p> <p><b>Cand trebuie puse in aplicare masurile de control a riscurilor?</b> Inainte de utilizarea stivuitorului.</p>



35	<p><b>Pericol identificat:</b></p> <p><b>In cazul in care exista un risc, masurile propuse a fi puse in aplicare sunt:</b></p> <p>Exista un risc? DA <input checked="" type="checkbox"/> NU <input type="checkbox"/> Exista un control a riscurilor posibile? DA <input checked="" type="checkbox"/> NU <input type="checkbox"/></p> <p>Nivel risc:</p> <p> <b>RIDICAT</b></p> <p><b>Cand trebuie puse in aplicare masurile de control a riscurilor?</b> Inainte de utilizarea stivuitorului.</p>
36	<p><b>Pericol identificat:</b></p> <p><b>In cazul in care exista un risc, masurile propuse a fi puse in aplicare sunt:</b></p> <p>Exista un risc? DA <input checked="" type="checkbox"/> NU <input type="checkbox"/> Exista un control a riscurilor posibile? DA <input checked="" type="checkbox"/> NU <input type="checkbox"/></p> <p>Nivel risc:</p> <p> <b>RIDICAT</b></p> <p><b>Cand trebuie puse in aplicare masurile de control a riscurilor?</b> Inainte de utilizarea stivuitorului.</p>

37	<p><b>Pericol identificat:</b></p> <p><b>In cazul in care exista un risc, masurile propuse a fi puse in aplicare sunt:</b></p> <p>Exista un risc? DA <input checked="" type="checkbox"/> NU <input type="checkbox"/> Exista un control a riscurilor posibile? DA <input checked="" type="checkbox"/> NU <input type="checkbox"/></p> <p>Nivel risc:</p> <p> <b>RIDICAT</b></p> <p><b>Cand trebuie puse in aplicare masurile de control a riscurilor?</b> Inainte de utilizarea stivuitorului.</p>
38	<p><b>Pericol identificat:</b></p> <p><b>In cazul in care exista un risc, masurile propuse a fi puse in aplicare sunt:</b></p> <p>Exista un risc? DA <input checked="" type="checkbox"/> NU <input type="checkbox"/> Exista un control a riscurilor posibile? DA <input checked="" type="checkbox"/> NU <input type="checkbox"/></p> <p>Nivel risc:</p> <p> <b>RIDICAT</b></p> <p><b>Cand trebuie puse in aplicare masurile de control a riscurilor?</b> Inainte de utilizarea stivuitorului.</p>



39	<p><b>Pericol identificat:</b></p> <p><b>In cazul in care exista un risc, masurile propuse a fi puse in aplicare sunt:</b></p> <p>Exista un risc? DA <input checked="" type="checkbox"/> NU <input type="checkbox"/> Exista un control a riscurilor posibile? DA <input checked="" type="checkbox"/> NU <input type="checkbox"/></p> <p>Nivel risc:</p> <p> <b>RIDICAT</b></p> <p><b>Cand trebuie puse in aplicare masurile de control a riscurilor?</b> Inainte de utilizarea stivuitorului.</p>
40	<p><b>Pericol identificat:</b></p> <p><b>In cazul in care exista un risc, masurile propuse a fi puse in aplicare sunt:</b></p> <p>Exista un risc? DA <input checked="" type="checkbox"/> NU <input type="checkbox"/> Exista un control a riscurilor posibile? DA <input checked="" type="checkbox"/> NU <input type="checkbox"/></p> <p>Nivel risc:</p> <p> <b>RIDICAT</b></p> <p><b>Cand trebuie puse in aplicare masurile de control a riscurilor?</b> Inainte de utilizarea stivuitorului.</p>



41	<p><b>Pericol identificat:</b></p> <p><b>In cazul in care exista un risc, masurile propuse a fi puse in aplicare sunt:</b></p> <p>Exista un risc? DA <input checked="" type="checkbox"/> NU <input type="checkbox"/> Exista un control a riscurilor posibile? DA <input checked="" type="checkbox"/> NU <input type="checkbox"/></p> <p>Nivel risc:</p> <p> <b>RIDICAT</b></p> <p><b>Cand trebuie puse in aplicare masurile de control a riscurilor?</b> Inainte de utilizarea stivuitorului.</p>
42	<p><b>Pericol identificat:</b></p> <p><b>In cazul in care exista un risc, masurile propuse a fi puse in aplicare sunt:</b></p> <p>Exista un risc? DA <input checked="" type="checkbox"/> NU <input type="checkbox"/> Exista un control a riscurilor posibile? DA <input checked="" type="checkbox"/> NU <input type="checkbox"/></p> <p>Nivel risc:</p> <p> <b>RIDICAT</b></p> <p><b>Cand trebuie puse in aplicare masurile de control a riscurilor?</b> Inainte de utilizarea stivuitorului.</p>



43	<p><b>Pericol identificat:</b></p> <p><b>In cazul in care exista un risc, masurile propuse a fi puse in aplicare sunt:</b></p> <p>Exista un risc? DA <input checked="" type="checkbox"/> NU <input type="checkbox"/> Exista un control a riscurilor posibile? DA <input checked="" type="checkbox"/> NU <input type="checkbox"/></p> <p>Nivel risc:</p> <p> <b>RIDICAT</b></p> <p><b>Cand trebuie puse in aplicare masurile de control a riscurilor?</b> Inainte de utilizarea stivuiitorului.</p>
44	<p><b>Pericol identificat:</b></p> <p><b>In cazul in care exista un risc, masurile propuse a fi puse in aplicare sunt:</b></p> <p>Exista un risc? DA <input checked="" type="checkbox"/> NU <input type="checkbox"/> Exista un control a riscurilor posibile? DA <input checked="" type="checkbox"/> NU <input type="checkbox"/></p> <p>Nivel risc:</p> <p> <b>RIDICAT</b></p> <p><b>Cand trebuie puse in aplicare masurile de control a riscurilor?</b> Inainte de utilizarea stivuiitorului.</p>



45	<p><b>Pericol identificat:</b></p> <p><b>In cazul in care exista un risc, masurile propuse a fi puse in aplicare sunt:</b></p> <p>Exista un risc? DA <input checked="" type="checkbox"/> NU <input type="checkbox"/> Exista un control a riscurilor posibile? DA <input checked="" type="checkbox"/> NU <input type="checkbox"/></p> <p>Nivel risc:</p> <p> <b>RIDICAT</b></p> <p><b>Cand trebuie puse in aplicare masurile de control a riscurilor?</b> Inainte de utilizarea stivuitorului.</p>
46	<p><b>Pericol identificat:</b></p> <p><b>In cazul in care exista un risc, masurile propuse a fi puse in aplicare sunt:</b></p> <p>Exista un risc? DA <input checked="" type="checkbox"/> NU <input type="checkbox"/> Exista un control a riscurilor posibile? DA <input checked="" type="checkbox"/> NU <input type="checkbox"/></p> <p>Nivel risc:</p> <p> <b>RIDICAT</b></p> <p><b>Cand trebuie puse in aplicare masurile de control a riscurilor?</b> Inainte de utilizarea stivuitorului.</p>







47	<p><b>Pericol identificat:</b></p> <p><b>In cazul in care exista un risc, masurile propuse a fi puse in aplicare sunt:</b></p> <p>Exista un risc? DA <input checked="" type="checkbox"/> NU <input type="checkbox"/> Exista un control a riscurilor posibile? DA <input checked="" type="checkbox"/> NU <input type="checkbox"/></p> <p>Nivel risc:</p> <p> <b>RIDICAT</b></p> <p><b>Cand trebuie puse in aplicare masurile de control a riscurilor?</b> Inainte de utilizarea stivuitorului.</p>
48	<p><b>Pericol identificat:</b></p> <p><b>In cazul in care exista un risc, masurile propuse a fi puse in aplicare sunt:</b></p> <p>Exista un risc? DA <input checked="" type="checkbox"/> NU <input type="checkbox"/> Exista un control a riscurilor posibile? DA <input checked="" type="checkbox"/> NU <input type="checkbox"/></p> <p>Nivel risc:</p> <p> <b>RIDICAT</b></p> <p><b>Cand trebuie puse in aplicare masurile de control a riscurilor?</b> Inainte de utilizarea stivuitorului.</p>



49	<p><b>Pericol identificat:</b></p> <p><b>In cazul in care exista un risc, masurile propuse a fi puse in aplicare sunt:</b></p> <p>Exista un risc? DA <input checked="" type="checkbox"/> NU <input type="checkbox"/> Exista un control a riscurilor posibile? DA <input checked="" type="checkbox"/> NU <input type="checkbox"/></p> <p>Nivel risc:</p> <p> <b>RIDICAT</b></p> <p><b>Cand trebuie puse in aplicare masurile de control a riscurilor?</b> Inainte de utilizarea stivuitorului.</p>
50	<p><b>Pericol identificat:</b></p> <p><b>In cazul in care exista un risc, masurile propuse a fi puse in aplicare sunt:</b></p> <p>Exista un risc? DA <input checked="" type="checkbox"/> NU <input type="checkbox"/> Exista un control a riscurilor posibile? DA <input checked="" type="checkbox"/> NU <input type="checkbox"/></p> <p>Nivel risc:</p> <p> <b>RIDICAT</b></p> <p><b>Cand trebuie puse in aplicare masurile de control a riscurilor?</b> Inainte de utilizarea stivuitorului.</p>



51	<p><b>Pericol identificat:</b></p> <p><b>In cazul in care exista un risc, masurile propuse a fi puse in aplicare sunt:</b></p> <p>Exista un risc? DA <input checked="" type="checkbox"/> NU <input type="checkbox"/> Exista un control a riscurilor posibile? DA <input checked="" type="checkbox"/> NU <input type="checkbox"/></p> <p>Nivel risc:</p> <p> <b>RIDICAT</b></p> <p><b>Cand trebuie puse in aplicare masurile de control a riscurilor?</b> Inainte de utilizarea stivuitorului.</p>
52	<p><b>Pericol identificat:</b></p> <p><b>In cazul in care exista un risc, masurile propuse a fi puse in aplicare sunt:</b></p> <p>Exista un risc? DA <input checked="" type="checkbox"/> NU <input type="checkbox"/> Exista un control a riscurilor posibile? DA <input checked="" type="checkbox"/> NU <input type="checkbox"/></p> <p>Nivel risc:</p> <p> <b>RIDICAT</b></p> <p><b>Cand trebuie puse in aplicare masurile de control a riscurilor?</b> Inainte de utilizarea stivuitorului.</p>

53	<p><b>Pericol identificat:</b></p> <p><b>In cazul in care exista un risc, masurile propuse a fi puse in aplicare sunt:</b></p> <p>Exista un risc? DA <input checked="" type="checkbox"/> NU <input type="checkbox"/> Exista un control a riscurilor posibile? DA <input checked="" type="checkbox"/> NU <input type="checkbox"/></p> <p>Nivel risc:</p> <p> <b>MEDIU</b></p> <p><b>Cand trebuie puse in aplicare masurile de control a riscurilor?</b> Inainte de utilizarea stivuitorului.</p>
54	<p><b>Pericol identificat:</b></p> <p><b>In cazul in care exista un risc, masurile propuse a fi puse in aplicare sunt:</b></p> <p>Exista un risc? DA <input checked="" type="checkbox"/> NU <input type="checkbox"/> Exista un control a riscurilor posibile? DA <input checked="" type="checkbox"/> NU <input type="checkbox"/></p> <p>Nivel risc:</p> <p> <b>MEDIU</b></p> <p><b>Cand trebuie puse in aplicare masurile de control a riscurilor?</b> Inainte de utilizarea stivuitorului.</p>



55	<p><b>Pericol identificat:</b></p> <p><b>In cazul in care exista un risc, masurile propuse a fi puse in aplicare sunt:</b></p> <p>Exista un risc? DA <input checked="" type="checkbox"/> NU <input type="checkbox"/> Exista un control a riscurilor posibile? DA <input checked="" type="checkbox"/> NU <input type="checkbox"/></p> <p>Nivel risc:</p> <p> <b>MEDIU</b></p> <p><b>Cand trebuie puse in aplicare masurile de control a riscurilor?</b> Inainte de utilizarea stivuitorului.</p>
56	<p><b>Pericol identificat:</b></p> <p><b>In cazul in care exista un risc, masurile propuse a fi puse in aplicare sunt:</b></p> <p>Exista un risc? DA <input checked="" type="checkbox"/> NU <input type="checkbox"/> Exista un control a riscurilor posibile? DA <input checked="" type="checkbox"/> NU <input type="checkbox"/></p> <p>Nivel risc:</p> <p> <b>MEDIU</b></p> <p><b>Cand trebuie puse in aplicare masurile de control a riscurilor?</b> Inainte de utilizarea stivuitorului.</p>



57	<p><b>Pericol identificat:</b></p> <p><b>In cazul in care exista un risc, masurile propuse a fi puse in aplicare sunt:</b></p> <p>Exista un risc? DA <input checked="" type="checkbox"/> NU <input type="checkbox"/> Exista un control a riscurilor posibile? DA <input checked="" type="checkbox"/> NU <input type="checkbox"/></p> <p>Nivel risc:</p> <p> <b>MEDIU</b></p> <p><b>Cand trebuie puse in aplicare masurile de control a riscurilor?</b> Inainte de utilizarea stivuitorului.</p>
58	<p><b>Pericol identificat:</b></p> <p><b>In cazul in care exista un risc, masurile propuse a fi puse in aplicare sunt:</b></p> <p>Exista un risc? DA <input checked="" type="checkbox"/> NU <input type="checkbox"/> Exista un control a riscurilor posibile? DA <input checked="" type="checkbox"/> NU <input type="checkbox"/></p> <p>Nivel risc:</p> <p> <b>RIDICAT</b></p> <p><b>Cand trebuie puse in aplicare masurile de control a riscurilor?</b> Inainte de utilizarea stivuitorului.</p>



59	<p><b>Pericol identificat:</b></p> <p><b>In cazul in care exista un risc, masurile propuse a fi puse in aplicare sunt:</b></p> <p>Exista un risc? DA <input checked="" type="checkbox"/> NU <input type="checkbox"/> Exista un control a riscurilor posibile? DA <input checked="" type="checkbox"/> NU <input type="checkbox"/></p> <p>Nivel risc:</p> <p> <b>RIDICAT</b></p> <p><b>Cand trebuie puse in aplicare masurile de control a riscurilor?</b> Inainte de utilizarea stivuitorului.</p>
60	<p><b>Pericol identificat:</b></p> <p><b>In cazul in care exista un risc, masurile propuse a fi puse in aplicare sunt:</b></p> <p>Exista un risc? DA <input checked="" type="checkbox"/> NU <input type="checkbox"/> Exista un control a riscurilor posibile? DA <input checked="" type="checkbox"/> NU <input type="checkbox"/></p> <p>Nivel risc:</p> <p> <b>RIDICAT</b></p> <p><b>Cand trebuie puse in aplicare masurile de control a riscurilor?</b> Inainte de utilizarea stivuitorului.</p>



<b>61</b>	<p><b>Pericol identificat:</b></p> <p style="text-align: right;"><b>In cazul in care exista un risc, masurile propuse a fi puse in aplicare sunt:</b></p> <p>Exista un risc? DA <input checked="" type="checkbox"/> NU <input type="checkbox"/>      Exista un control a riscurilor posibile? DA <input checked="" type="checkbox"/> NU <input type="checkbox"/></p> <p>Nivel risc:</p> <p> <b>RIDICAT</b></p> <p><b>Cand trebuie puse in aplicare masurile de control a riscurilor?</b> Inainte de utilizarea stivuiorului.</p>
<b>62</b>	<p><b>Pericol identificat:</b></p> <p style="text-align: right;"><b>In cazul in care exista un risc, masurile propuse a fi puse in aplicare sunt:</b></p> <p>Exista un risc? DA <input checked="" type="checkbox"/> NU <input type="checkbox"/>      Exista un control a riscurilor posibile? DA <input checked="" type="checkbox"/> NU <input type="checkbox"/></p> <p>Nivel risc:</p> <p> <b>RIDICAT</b></p> <p><b>Cand trebuie puse in aplicare masurile de control a riscurilor?</b> Inainte de utilizarea stivuiorului.</p>







63	<p><b>Pericol identificat:</b></p> <p><b>In cazul in care exista un risc, masurile propuse a fi puse in aplicare sunt:</b></p> <p>Exista un risc? DA <input type="checkbox"/> NU <input checked="" type="checkbox"/> Exista un control a riscurilor posibile? DA <input checked="" type="checkbox"/> NU <input type="checkbox"/></p> <p>Nivel risc:</p> <p> SCAZUT</p> <p><b>Cand trebuie puse in aplicare masurile de control a riscurilor?</b> Inainte de utilizarea stivuitorului.</p>
64	<p><b>Pericol identificat:</b></p> <p><b>In cazul in care exista un risc, masurile propuse a fi puse in aplicare sunt:</b></p> <p>Exista un risc? DA <input type="checkbox"/> NU <input checked="" type="checkbox"/> Exista un control a riscurilor posibile? DA <input checked="" type="checkbox"/> NU <input type="checkbox"/></p> <p>Nivel risc:</p> <p> SCAZUT</p> <p><b>Cand trebuie puse in aplicare masurile de control a riscurilor?</b> Inainte de utilizarea stivuitorului.</p>



65	<p><b>Pericol identificat:</b></p> <p><b>In cazul in care exista un risc, masurile propuse a fi puse in aplicare sunt:</b></p> <p>Exista un risc? DA <input checked="" type="checkbox"/> NU <input type="checkbox"/> Exista un control a riscurilor posibile? DA <input checked="" type="checkbox"/> NU <input type="checkbox"/></p> <p>Nivel risc:</p> <p> <b>RIDICAT</b></p> <p><b>Cand trebuie puse in aplicare masurile de control a riscurilor?</b> Inainte de utilizarea stivuitorului.</p>
66	<p><b>Pericol identificat:</b></p> <p><b>In cazul in care exista un risc, masurile propuse a fi puse in aplicare sunt:</b></p> <p>Exista un risc? DA <input checked="" type="checkbox"/> NU <input type="checkbox"/> Exista un control a riscurilor posibile? DA <input checked="" type="checkbox"/> NU <input type="checkbox"/></p> <p>Nivel risc:</p> <p> <b>RIDICAT</b></p> <p><b>Cand trebuie puse in aplicare masurile de control a riscurilor?</b> Inainte de utilizarea stivuitorului.</p>



67	<p><b>Pericol identificat:</b></p> <p><b>In cazul in care exista un risc, masurile propuse a fi puse in aplicare sunt:</b></p> <p>Exista un risc? DA <input type="checkbox"/> NU <input checked="" type="checkbox"/> Exista un control a riscurilor posibile? DA <input checked="" type="checkbox"/> NU <input type="checkbox"/></p> <p>Nivel risc:</p> <p> SCAZUT</p> <p><b>Cand trebuie puse in aplicare masurile de control a riscurilor?</b> Inainte de utilizarea stivuitorului.</p>
68	<p><b>Pericol identificat:</b></p> <p><b>In cazul in care exista un risc, masurile propuse a fi puse in aplicare sunt:</b></p> <p>Exista un risc? DA <input checked="" type="checkbox"/> NU <input type="checkbox"/> Exista un control a riscurilor posibile? DA <input checked="" type="checkbox"/> NU <input type="checkbox"/></p> <p>Nivel risc:</p> <p> RIDICAT</p> <p><b>Cand trebuie puse in aplicare masurile de control a riscurilor?</b> Inainte de utilizarea stivuitorului.</p>

69	<p><b>Pericol identificat:</b></p> <p><b>In cazul in care exista un risc, masurile propuse a fi puse in aplicare sunt:</b></p> <p>Exista un risc? DA <input type="checkbox"/> NU <input checked="" type="checkbox"/> Exista un control a riscurilor posibile? DA <input checked="" type="checkbox"/> NU <input type="checkbox"/></p> <p>Nivel risc:  SCAZUT</p> <p><b>Cand trebuie puse in aplicare masurile de control a riscurilor?</b> Inainte de utilizarea stivuitorului.</p>
70	<p><b>Pericol identificat:</b></p> <p><b>In cazul in care exista un risc, masurile propuse a fi puse in aplicare sunt:</b></p> <p>Exista un risc? DA <input checked="" type="checkbox"/> NU <input type="checkbox"/> Exista un control a riscurilor posibile? DA <input checked="" type="checkbox"/> NU <input type="checkbox"/></p> <p>Nivel risc:  RIDICAT</p> <p><b>Cand trebuie puse in aplicare masurile de control a riscurilor?</b> Inainte de utilizarea stivuitorului.</p>



71	<p><b>Pericol identificat:</b></p> <p><b>In cazul in care exista un risc, masurile propuse a fi puse in aplicare sunt:</b></p> <p>Exista un risc? DA <input checked="" type="checkbox"/> NU <input type="checkbox"/> Exista un control a riscurilor posibile? DA <input checked="" type="checkbox"/> NU <input type="checkbox"/></p> <p>Nivel risc:</p> <p> <b>RIDICAT</b></p> <p><b>Cand trebuie puse in aplicare masurile de control a riscurilor?</b> Inainte de utilizarea stivuitorului.</p>
72	<p><b>Pericol identificat:</b></p> <p><b>In cazul in care exista un risc, masurile propuse a fi puse in aplicare sunt:</b></p> <p>Exista un risc? DA <input checked="" type="checkbox"/> NU <input type="checkbox"/> Exista un control a riscurilor posibile? DA <input checked="" type="checkbox"/> NU <input type="checkbox"/></p> <p>Nivel risc:</p> <p> <b>RIDICAT</b></p> <p><b>Cand trebuie puse in aplicare masurile de control a riscurilor?</b> Inainte de utilizarea stivuitorului.</p>



<p>73</p>	<p><b>Pericol identificat:</b></p> <p style="text-align: right;"><b>In cazul in care exista un risc, masurile propuse a fi puse in aplicare sunt:</b></p> <p>Exista un risc? DA <input checked="" type="checkbox"/> NU <input type="checkbox"/>      Exista un control a riscurilor posibile? DA <input checked="" type="checkbox"/> NU <input type="checkbox"/></p> <p>Nivel risc:</p> <p> <b>RIDICAT</b></p> <p><b>Cand trebuie puse in aplicare masurile de control a riscurilor?</b> Inainte de utilizarea stivuitorului.</p>
<p>74</p>	<p><b>Pericol identificat:</b></p> <p style="text-align: right;"><b>In cazul in care exista un risc, masurile propuse a fi puse in aplicare sunt:</b></p> <p>Exista un risc? DA <input checked="" type="checkbox"/> NU <input type="checkbox"/>      Exista un control a riscurilor posibile? DA <input checked="" type="checkbox"/> NU <input type="checkbox"/></p> <p>Nivel risc:</p> <p> <b>RIDICAT</b></p> <p><b>Cand trebuie puse in aplicare masurile de control a riscurilor?</b> Inainte de utilizarea stivuitorului.</p>



75	<p><b>Pericol identificat:</b></p> <p><b>In cazul in care exista un risc, masurile propuse a fi puse in aplicare sunt:</b></p> <p>Exista un risc? DA <input checked="" type="checkbox"/> NU <input type="checkbox"/> Exista un control a riscurilor posibile? DA <input checked="" type="checkbox"/> NU <input type="checkbox"/></p> <p>Nivel risc:</p> <p> <b>MEDIU</b></p> <p><b>Cand trebuie puse in aplicare masurile de control a riscurilor?</b> Inainte de utilizarea stivuitorului.</p>
76	<p><b>Pericol identificat:</b></p> <p><b>In cazul in care exista un risc, masurile propuse a fi puse in aplicare sunt:</b></p> <p>Exista un risc? DA <input checked="" type="checkbox"/> NU <input type="checkbox"/> Exista un control a riscurilor posibile? DA <input checked="" type="checkbox"/> NU <input type="checkbox"/></p> <p>Nivel risc:</p> <p> <b>RIDICAT</b></p> <p><b>Cand trebuie puse in aplicare masurile de control a riscurilor?</b> Inainte de utilizarea stivuitorului.</p>



77	<p><b>Pericol identificat:</b></p> <p><b>In cazul in care exista un risc, masurile propuse a fi puse in aplicare sunt:</b></p> <p>Exista un risc? DA <input checked="" type="checkbox"/> NU <input type="checkbox"/> Exista un control a riscurilor posibile? DA <input checked="" type="checkbox"/> NU <input type="checkbox"/></p> <p>Nivel risc:</p> <p> <b>RIDICAT</b></p> <p><b>Cand trebuie puse in aplicare masurile de control a riscurilor?</b> Inainte de utilizarea stivuitorului.</p>
78	<p><b>Pericol identificat:</b></p> <p><b>In cazul in care exista un risc, masurile propuse a fi puse in aplicare sunt:</b></p> <p>Exista un risc? DA <input checked="" type="checkbox"/> NU <input type="checkbox"/> Exista un control a riscurilor posibile? DA <input checked="" type="checkbox"/> NU <input type="checkbox"/></p> <p>Nivel risc:</p> <p> <b>RIDICAT</b></p> <p><b>Cand trebuie puse in aplicare masurile de control a riscurilor?</b> Inainte de utilizarea stivuitorului.</p>







79	<p><b>Pericol identificat:</b></p> <p><b>In cazul in care exista un risc, masurile propuse a fi puse in aplicare sunt:</b></p> <p>Exista un risc? DA <input checked="" type="checkbox"/> NU <input type="checkbox"/> Exista un control a riscurilor posibile? DA <input checked="" type="checkbox"/> NU <input type="checkbox"/></p> <p>Nivel risc:</p> <p> <b>MEDIU</b></p> <p><b>Cand trebuie puse in aplicare masurile de control a riscurilor?</b> Inainte de utilizarea stivuitorului.</p>
80	<p><b>Pericol identificat:</b></p> <p><b>In cazul in care exista un risc, masurile propuse a fi puse in aplicare sunt:</b></p> <p>Exista un risc? DA <input type="checkbox"/> NU <input checked="" type="checkbox"/> Exista un control a riscurilor posibile? DA <input checked="" type="checkbox"/> NU <input type="checkbox"/></p> <p>Nivel risc:</p> <p> <b>SCAZUT</b></p> <p><b>Cand trebuie puse in aplicare masurile de control a riscurilor?</b> Inainte de utilizarea stivuitorului.</p>



81	<p><b>Pericol identificat:</b></p> <p><b>In cazul in care exista un risc, masurile propuse a fi puse in aplicare sunt:</b></p> <p>Exista un risc? DA <input checked="" type="checkbox"/> NU <input type="checkbox"/> Exista un control a riscurilor posibile? DA <input checked="" type="checkbox"/> NU <input type="checkbox"/></p> <p>Nivel risc:</p> <p> <b>MEDIU</b></p> <p><b>Cand trebuie puse in aplicare masurile de control a riscurilor?</b> Inainte de utilizarea stivuitorului.</p>
82	<p><b>Pericol identificat:</b></p> <p><b>In cazul in care exista un risc, masurile propuse a fi puse in aplicare sunt:</b></p> <p>Exista un risc? DA <input checked="" type="checkbox"/> NU <input type="checkbox"/> Exista un control a riscurilor posibile? DA <input checked="" type="checkbox"/> NU <input type="checkbox"/></p> <p>Nivel risc:</p> <p> <b>RIDICAT</b></p> <p><b>Cand trebuie puse in aplicare masurile de control a riscurilor?</b> Inainte de utilizarea stivuitorului.</p>



83	<p><b>Pericol identificat:</b></p> <p><b>In cazul in care exista un risc, masurile propuse a fi puse in aplicare sunt:</b></p> <p>Exista un risc? DA <input checked="" type="checkbox"/> NU <input type="checkbox"/> Exista un control a riscurilor posibile? DA <input checked="" type="checkbox"/> NU <input type="checkbox"/></p> <p>Nivel risc:</p> <p> <b>MEDIU</b></p> <p><b>Cand trebuie puse in aplicare masurile de control a riscurilor?</b> Inainte de utilizarea stivuitorului.</p>
84	<p><b>Pericol identificat:</b></p> <p><b>In cazul in care exista un risc, masurile propuse a fi puse in aplicare sunt:</b></p> <p>Exista un risc? DA <input checked="" type="checkbox"/> NU <input type="checkbox"/> Exista un control a riscurilor posibile? DA <input checked="" type="checkbox"/> NU <input type="checkbox"/></p> <p>Nivel risc:</p> <p> <b>MEDIU</b></p> <p><b>Cand trebuie puse in aplicare masurile de control a riscurilor?</b> Inainte de utilizarea stivuitorului.</p>

85	<p><b>Pericol identificat:</b></p> <p><b>In cazul in care exista un risc, masurile propuse a fi puse in aplicare sunt:</b></p> <p>Exista un risc? DA <input checked="" type="checkbox"/> NU <input type="checkbox"/> Exista un control a riscurilor posibile? DA <input checked="" type="checkbox"/> NU <input type="checkbox"/></p> <p>Nivel risc:</p> <p> <b>RIDICAT</b></p> <p><b>Cand trebuie puse in aplicare masurile de control a riscurilor?</b> Inainte de utilizarea stivuitorului.</p>
86	<p><b>Pericol identificat:</b></p> <p><b>In cazul in care exista un risc, masurile propuse a fi puse in aplicare sunt:</b></p> <p>Exista un risc? DA <input checked="" type="checkbox"/> NU <input type="checkbox"/> Exista un control a riscurilor posibile? DA <input checked="" type="checkbox"/> NU <input type="checkbox"/></p> <p>Nivel risc:</p> <p> <b>RIDICAT</b></p> <p><b>Cand trebuie puse in aplicare masurile de control a riscurilor?</b> Inainte de utilizarea stivuitorului.</p>



87	<p><b>Pericol identificat:</b></p> <p><b>In cazul in care exista un risc, masurile propuse a fi puse in aplicare sunt:</b></p> <p>Exista un risc? DA <input checked="" type="checkbox"/> NU <input type="checkbox"/> Exista un control a riscurilor posibile? DA <input checked="" type="checkbox"/> NU <input type="checkbox"/></p> <p>Nivel risc:</p> <p> <b>RIDICAT</b></p> <p><b>Cand trebuie puse in aplicare masurile de control a riscurilor?</b> Inainte de utilizarea stivuitorului.</p>
88	<p><b>Pericol identificat:</b></p> <p><b>In cazul in care exista un risc, masurile propuse a fi puse in aplicare sunt:</b></p> <p>Exista un risc? DA <input checked="" type="checkbox"/> NU <input type="checkbox"/> Exista un control a riscurilor posibile? DA <input checked="" type="checkbox"/> NU <input type="checkbox"/></p> <p>Nivel risc:</p> <p> <b>RIDICAT</b></p> <p><b>Cand trebuie puse in aplicare masurile de control a riscurilor?</b> Inainte de utilizarea stivuitorului.</p>



89	<p><b>Pericol identificat:</b></p> <p><b>In cazul in care exista un risc, masurile propuse a fi puse in aplicare sunt:</b></p> <p>Exista un risc? DA <input checked="" type="checkbox"/> NU <input type="checkbox"/> Exista un control a riscurilor posibile? DA <input checked="" type="checkbox"/> NU <input type="checkbox"/></p> <p>Nivel risc:</p> <p> <b>MEDIU</b></p> <p><b>Cand trebuie puse in aplicare masurile de control a riscurilor?</b> Inainte de utilizarea stivuitorului.</p>
90	<p><b>Pericol identificat:</b></p> <p><b>In cazul in care exista un risc, masurile propuse a fi puse in aplicare sunt:</b></p> <p>Exista un risc? DA <input checked="" type="checkbox"/> NU <input type="checkbox"/> Exista un control a riscurilor posibile? DA <input checked="" type="checkbox"/> NU <input type="checkbox"/></p> <p>Nivel risc:</p> <p> <b>RIDICAT</b></p> <p><b>Cand trebuie puse in aplicare masurile de control a riscurilor?</b> Inainte de utilizarea stivuitorului.</p>



91	<p><b>Pericol identificat:</b></p> <p><b>In cazul in care exista un risc, masurile propuse a fi puse in aplicare sunt:</b></p> <p>Exista un risc? DA <input checked="" type="checkbox"/> NU <input type="checkbox"/> Exista un control a riscurilor posibile? DA <input checked="" type="checkbox"/> NU <input type="checkbox"/></p> <p>Nivel risc:</p> <p> <b>RIDICAT</b></p> <p><b>Cand trebuie puse in aplicare masurile de control a riscurilor?</b> Inainte de utilizarea stivuitorului.</p>
92	<p><b>Pericol identificat:</b></p> <p><b>In cazul in care exista un risc, masurile propuse a fi puse in aplicare sunt:</b></p> <p>Exista un risc? DA <input checked="" type="checkbox"/> NU <input type="checkbox"/> Exista un control a riscurilor posibile? DA <input checked="" type="checkbox"/> NU <input type="checkbox"/></p> <p>Nivel risc:</p> <p> <b>RIDICAT</b></p> <p><b>Cand trebuie puse in aplicare masurile de control a riscurilor?</b> Inainte de utilizarea stivuitorului.</p>



<p>93</p>	<p><b>Pericol identificat:</b></p> <p style="text-align: right;"><b>In cazul in care exista un risc, masurile propuse a fi puse in aplicare sunt:</b></p>  <p>Exista un risc? DA <input checked="" type="checkbox"/> NU <input type="checkbox"/>      Exista un control a riscurilor posibile? DA <input checked="" type="checkbox"/> NU <input type="checkbox"/></p> <p>Nivel risc:</p> <p> <b>RIDICAT</b></p> <p><b>Cand trebuie puse in aplicare masurile de control a riscurilor?</b> Inainte de utilizarea stivuiitorului.</p>
<p>94</p>	<p><b>Pericol identificat:</b></p> <p style="text-align: right;"><b>In cazul in care exista un risc, masurile propuse a fi puse in aplicare sunt:</b></p>  <p>Exista un risc? DA <input checked="" type="checkbox"/> NU <input type="checkbox"/>      Exista un control a riscurilor posibile? DA <input checked="" type="checkbox"/> NU <input type="checkbox"/></p> <p>Nivel risc:</p> <p> <b>RIDICAT</b></p> <p><b>Cand trebuie puse in aplicare masurile de control a riscurilor?</b> Inainte de utilizarea stivuiitorului.</p>







95	<p><b>Pericol identificat:</b></p> <p><b>In cazul in care exista un risc, masurile propuse a fi puse in aplicare sunt:</b></p> <p>Exista un risc? DA <input checked="" type="checkbox"/> NU <input type="checkbox"/> Exista un control a riscurilor posibile? DA <input checked="" type="checkbox"/> NU <input type="checkbox"/></p> <p>Nivel risc:</p> <p> <b>RIDICAT</b></p> <p><b>Cand trebuie puse in aplicare masurile de control a riscurilor?</b> Inainte de utilizarea stivuitorului.</p>
96	<p><b>Pericol identificat:</b></p> <p><b>In cazul in care exista un risc, masurile propuse a fi puse in aplicare sunt:</b></p> <p>Exista un risc? DA <input checked="" type="checkbox"/> NU <input type="checkbox"/> Exista un control a riscurilor posibile? DA <input checked="" type="checkbox"/> NU <input type="checkbox"/></p> <p>Nivel risc:</p> <p> <b>RIDICAT</b></p> <p><b>Cand trebuie puse in aplicare masurile de control a riscurilor?</b> Inainte de utilizarea stivuitorului.</p>



97	<p><b>Pericol identificat:</b></p> <p><b>In cazul in care exista un risc, masurile propuse a fi puse in aplicare sunt:</b></p> <p>Exista un risc? DA <input checked="" type="checkbox"/> NU <input type="checkbox"/> Exista un control a riscurilor posibile? DA <input checked="" type="checkbox"/> NU <input type="checkbox"/></p> <p>Nivel risc:</p> <p> <b>RIDICAT</b></p> <p><b>Cand trebuie puse in aplicare masurile de control a riscurilor?</b> Inainte de utilizarea stivuitorului.</p>
98	<p><b>Pericol identificat:</b></p> <p><b>In cazul in care exista un risc, masurile propuse a fi puse in aplicare sunt:</b></p> <p>Exista un risc? DA <input checked="" type="checkbox"/> NU <input type="checkbox"/> Exista un control a riscurilor posibile? DA <input checked="" type="checkbox"/> NU <input type="checkbox"/></p> <p>Nivel risc:</p> <p> <b>RIDICAT</b></p> <p><b>Cand trebuie puse in aplicare masurile de control a riscurilor?</b> Inainte de utilizarea stivuitorului.</p>



<p>99</p>	<p><b>Pericol identificat:</b></p> <p style="text-align: right;"><b>In cazul in care exista un risc, masurile propuse a fi puse in aplicare sunt:</b></p> <p>Exista un risc? DA <input checked="" type="checkbox"/> NU <input type="checkbox"/>      Exista un control a riscurilor posibile? DA <input checked="" type="checkbox"/> NU <input type="checkbox"/></p> <p>Nivel risc:</p> <p> <b>RIDICAT</b></p> <p><b>Cand trebuie puse in aplicare masurile de control a riscurilor?</b> Inainte de utilizarea stivuitorului.</p>
<p>100</p>	<p><b>Pericol identificat:</b></p> <p style="text-align: right;"><b>In cazul in care exista un risc, masurile propuse a fi puse in aplicare sunt:</b></p> <p>Exista un risc? DA <input checked="" type="checkbox"/> NU <input type="checkbox"/>      Exista un control a riscurilor posibile? DA <input checked="" type="checkbox"/> NU <input type="checkbox"/></p> <p>Nivel risc:</p> <p> <b>RIDICAT</b></p> <p><b>Cand trebuie puse in aplicare masurile de control a riscurilor?</b> Inainte de utilizarea stivuitorului.</p>

101	<p><b>Pericol identificat:</b></p> <p><b>In cazul in care exista un risc, masurile propuse a fi puse in aplicare sunt:</b></p> <p>Exista un risc? DA <input checked="" type="checkbox"/> NU <input type="checkbox"/> Exista un control a riscurilor posibile? DA <input checked="" type="checkbox"/> NU <input type="checkbox"/></p> <p>Nivel risc:</p> <p> <b>RIDICAT</b></p> <p><b>Cand trebuie puse in aplicare masurile de control a riscurilor?</b> Inainte de utilizarea stivuitorului.</p>
102	<p><b>Pericol identificat:</b></p> <p><b>In cazul in care exista un risc, masurile propuse a fi puse in aplicare sunt:</b></p> <p>Exista un risc? DA <input checked="" type="checkbox"/> NU <input type="checkbox"/> Exista un control a riscurilor posibile? DA <input checked="" type="checkbox"/> NU <input type="checkbox"/></p> <p>Nivel risc:</p> <p> <b>RIDICAT</b></p> <p><b>Cand trebuie puse in aplicare masurile de control a riscurilor?</b> Inainte de utilizarea stivuitorului.</p>



103	<p><b>Pericol identificat:</b></p> <p><b>In cazul in care exista un risc, masurile propuse a fi puse in aplicare sunt:</b></p> <p>Exista un risc? DA <input type="checkbox"/> NU <input checked="" type="checkbox"/> Exista un control a riscurilor posibile? DA <input checked="" type="checkbox"/> NU <input type="checkbox"/></p> <p>Nivel risc:</p> <p> SCAZUT</p> <p><b>Cand trebuie puse in aplicare masurile de control a riscurilor?</b> Inainte de utilizarea stivuitorului.</p>
104	<p><b>Pericol identificat:</b></p> <p><b>In cazul in care exista un risc, masurile propuse a fi puse in aplicare sunt:</b></p> <p>Exista un risc? DA <input checked="" type="checkbox"/> NU <input type="checkbox"/> Exista un control a riscurilor posibile? DA <input checked="" type="checkbox"/> NU <input type="checkbox"/></p> <p>Nivel risc:</p> <p> RIDICAT</p> <p><b>Cand trebuie puse in aplicare masurile de control a riscurilor?</b> Inainte de utilizarea stivuitorului.</p>



105	<p><b>Pericol identificat:</b></p> <p><b>In cazul in care exista un risc, masurile propuse a fi puse in aplicare sunt:</b></p> <p>Exista un risc? DA <input checked="" type="checkbox"/> NU <input type="checkbox"/>      Exista un control a riscurilor posibile? DA <input checked="" type="checkbox"/> NU <input type="checkbox"/></p> <p>Nivel risc:</p> <p> <b>RIDICAT</b></p> <p><b>Cand trebuie puse in aplicare masurile de control a riscurilor?</b> Inainte de utilizarea stivuitorului.</p>
106	<p><b>Pericol identificat:</b></p> <p><b>In cazul in care exista un risc, masurile propuse a fi puse in aplicare sunt:</b></p> <p>Exista un risc? DA <input checked="" type="checkbox"/> NU <input type="checkbox"/>      Exista un control a riscurilor posibile? DA <input checked="" type="checkbox"/> NU <input type="checkbox"/></p> <p>Nivel risc:</p> <p> <b>RIDICAT</b></p> <p><b>Cand trebuie puse in aplicare masurile de control a riscurilor?</b> Inainte de utilizarea stivuitorului.</p>



107	<p><b>Pericol identificat:</b></p> <p><b>In cazul in care exista un risc, masurile propuse a fi puse in aplicare sunt:</b></p> <p>Exista un risc? DA <input checked="" type="checkbox"/> NU <input type="checkbox"/> Exista un control a riscurilor posibile? DA <input checked="" type="checkbox"/> NU <input type="checkbox"/></p> <p>Nivel risc:</p> <p> <b>RIDICAT</b></p> <p><b>Cand trebuie puse in aplicare masurile de control a riscurilor?</b> Inainte de utilizarea stivuitorului.</p>
108	<p><b>Pericol identificat:</b></p> <p><b>In cazul in care exista un risc, masurile propuse a fi puse in aplicare sunt:</b></p> <p>Exista un risc? DA <input checked="" type="checkbox"/> NU <input type="checkbox"/> Exista un control a riscurilor posibile? DA <input checked="" type="checkbox"/> NU <input type="checkbox"/></p> <p>Nivel risc:</p> <p> <b>RIDICAT</b></p> <p><b>Cand trebuie puse in aplicare masurile de control a riscurilor?</b> Inainte de utilizarea stivuitorului.</p>



109	<b>Pericol identificat:</b>	<b>In cazul in care exista un risc, masurile propuse a fi puse in aplicare sunt:</b>  Exista un risc? DA <input checked="" type="checkbox"/> NU <input type="checkbox"/> Exista un control a riscurilor posibile? DA <input checked="" type="checkbox"/> NU <input type="checkbox"/> <b>Nivel risc:</b>  <b>RIDICAT</b> <b>Cand trebuie puse in aplicare masurile de control a riscurilor?</b> Inainte de utilizarea stivuitorului.
110	<b>Pericol identificat:</b>	<b>In cazul in care exista un risc, masurile propuse a fi puse in aplicare sunt:</b>  Exista un risc? DA <input checked="" type="checkbox"/> NU <input type="checkbox"/> Exista un control a riscurilor posibile? DA <input checked="" type="checkbox"/> NU <input type="checkbox"/> <b>Nivel risc:</b>  <b>RIDICAT</b> <b>Cand trebuie puse in aplicare masurile de control a riscurilor?</b> Inainte de utilizarea stivuitorului.







111	<p><b>Pericol identificat:</b></p> <p><b>In cazul in care exista un risc, masurile propuse a fi puse in aplicare sunt:</b></p> <p>Exista un risc? DA <input checked="" type="checkbox"/> NU <input type="checkbox"/> Exista un control a riscurilor posibile? DA <input checked="" type="checkbox"/> NU <input type="checkbox"/></p> <p>Nivel risc:</p> <p> <b>RIDICAT</b></p> <p><b>Cand trebuie puse in aplicare masurile de control a riscurilor?</b> Inainte de utilizarea stivuitorului.</p>
112	<p><b>Pericol identificat:</b></p> <p><b>In cazul in care exista un risc, masurile propuse a fi puse in aplicare sunt:</b></p> <p>Exista un risc? DA <input checked="" type="checkbox"/> NU <input type="checkbox"/> Exista un control a riscurilor posibile? DA <input checked="" type="checkbox"/> NU <input type="checkbox"/></p> <p>Nivel risc:</p> <p> <b>RIDICAT</b></p> <p><b>Cand trebuie puse in aplicare masurile de control a riscurilor?</b> Inainte de utilizarea stivuitorului.</p>



113	<p><b>Pericol identificat:</b></p> <p><b>In cazul in care exista un risc, masurile propuse a fi puse in aplicare sunt:</b></p> <p>Exista un risc? DA <input checked="" type="checkbox"/> NU <input type="checkbox"/> Exista un control a riscurilor posibile? DA <input checked="" type="checkbox"/> NU <input type="checkbox"/></p> <p>Nivel risc:</p> <p> <b>RIDICAT</b></p> <p><b>Cand trebuie puse in aplicare masurile de control a riscurilor?</b> Inainte de utilizarea stivuitorului.</p>
114	<p><b>Pericol identificat:</b></p> <p><b>In cazul in care exista un risc, masurile propuse a fi puse in aplicare sunt:</b></p> <p>Exista un risc? DA <input checked="" type="checkbox"/> NU <input type="checkbox"/> Exista un control a riscurilor posibile? DA <input checked="" type="checkbox"/> NU <input type="checkbox"/></p> <p>Nivel risc:</p> <p> <b>RIDICAT</b></p> <p><b>Cand trebuie puse in aplicare masurile de control a riscurilor?</b> Inainte de utilizarea stivuitorului.</p>



115	<p><b>Pericol identificat:</b></p> <p><b>In cazul in care exista un risc, masurile propuse a fi puse in aplicare sunt:</b></p> <p>Exista un risc? DA <input checked="" type="checkbox"/> NU <input type="checkbox"/> Exista un control a riscurilor posibile? DA <input checked="" type="checkbox"/> NU <input type="checkbox"/></p> <p>Nivel risc:</p> <p> <b>RIDICAT</b></p> <p><b>Cand trebuie puse in aplicare masurile de control a riscurilor?</b> Inainte de utilizarea stivuitorului.</p>
116	<p><b>Pericol identificat:</b></p> <p><b>In cazul in care exista un risc, masurile propuse a fi puse in aplicare sunt:</b></p> <p>Exista un risc? DA <input checked="" type="checkbox"/> NU <input type="checkbox"/> Exista un control a riscurilor posibile? DA <input checked="" type="checkbox"/> NU <input type="checkbox"/></p> <p>Nivel risc:</p> <p> <b>RIDICAT</b></p> <p><b>Cand trebuie puse in aplicare masurile de control a riscurilor?</b> Inainte de utilizarea stivuitorului.</p>

117	<p><b>Pericol identificat:</b></p> <p><b>In cazul in care exista un risc, masurile propuse a fi puse in aplicare sunt:</b></p> <p>Exista un risc? DA <input checked="" type="checkbox"/> NU <input type="checkbox"/> Exista un control a riscurilor posibile? DA <input checked="" type="checkbox"/> NU <input type="checkbox"/></p> <p>Nivel risc:</p> <p> <b>RIDICAT</b></p> <p><b>Cand trebuie puse in aplicare masurile de control a riscurilor?</b> Inainte de utilizarea stivuitorului.</p>
118	<p><b>Pericol identificat:</b></p> <p><b>In cazul in care exista un risc, masurile propuse a fi puse in aplicare sunt:</b></p> <p>Exista un risc? DA <input checked="" type="checkbox"/> NU <input type="checkbox"/> Exista un control a riscurilor posibile? DA <input checked="" type="checkbox"/> NU <input type="checkbox"/></p> <p>Nivel risc:</p> <p> <b>RIDICAT</b></p> <p><b>Cand trebuie puse in aplicare masurile de control a riscurilor?</b> Inainte de utilizarea stivuitorului.</p>



119	<p><b>Pericol identificat:</b></p> <p><b>In cazul in care exista un risc, masurile propuse a fi puse in aplicare sunt:</b></p> <p>Exista un risc? DA <input checked="" type="checkbox"/> NU <input type="checkbox"/> Exista un control a riscurilor posibile? DA <input checked="" type="checkbox"/> NU <input type="checkbox"/></p> <p>Nivel risc:</p> <p> <b>MEDIU</b></p> <p><b>Cand trebuie puse in aplicare masurile de control a riscurilor?</b> Inainte de utilizarea stivuitorului.</p>
120	<p><b>Pericol identificat:</b></p> <p><b>In cazul in care exista un risc, masurile propuse a fi puse in aplicare sunt:</b></p> <p>Exista un risc? DA <input checked="" type="checkbox"/> NU <input type="checkbox"/> Exista un control a riscurilor posibile? DA <input checked="" type="checkbox"/> NU <input type="checkbox"/></p> <p>Nivel risc:</p> <p> <b>RIDICAT</b></p> <p><b>Cand trebuie puse in aplicare masurile de control a riscurilor?</b> Inainte de utilizarea stivuitorului.</p>



121	<p><b>Pericol identificat:</b></p> <p><b>In cazul in care exista un risc, masurile propuse a fi puse in aplicare sunt:</b></p> <p>Exista un risc? DA <input checked="" type="checkbox"/> NU <input type="checkbox"/> Exista un control a riscurilor posibile? DA <input checked="" type="checkbox"/> NU <input type="checkbox"/></p> <p>Nivel risc:</p> <p> <b>RIDICAT</b></p> <p><b>Cand trebuie puse in aplicare masurile de control a riscurilor?</b> Inainte de utilizarea stivuitorului.</p>
122	<p><b>Pericol identificat:</b></p> <p><b>In cazul in care exista un risc, masurile propuse a fi puse in aplicare sunt:</b></p> <p>Exista un risc? DA <input checked="" type="checkbox"/> NU <input type="checkbox"/> Exista un control a riscurilor posibile? DA <input checked="" type="checkbox"/> NU <input type="checkbox"/></p> <p>Nivel risc:</p> <p> <b>RIDICAT</b></p> <p><b>Cand trebuie puse in aplicare masurile de control a riscurilor?</b> Inainte de utilizarea stivuitorului.</p>



123	<p><b>Pericol identificat:</b></p> <p><b>In cazul in care exista un risc, masurile propuse a fi puse in aplicare sunt:</b></p> <p>Exista un risc? DA <input checked="" type="checkbox"/> NU <input type="checkbox"/> Exista un control a riscurilor posibile? DA <input checked="" type="checkbox"/> NU <input type="checkbox"/></p> <p>Nivel risc:</p> <p> <b>RIDICAT</b></p> <p><b>Cand trebuie puse in aplicare masurile de control a riscurilor?</b> Inainte de utilizarea stivuitorului.</p>
124	<p><b>Pericol identificat:</b></p> <p><b>In cazul in care exista un risc, masurile propuse a fi puse in aplicare sunt:</b></p> <p>Exista un risc? DA <input checked="" type="checkbox"/> NU <input type="checkbox"/> Exista un control a riscurilor posibile? DA <input checked="" type="checkbox"/> NU <input type="checkbox"/></p> <p>Nivel risc:</p> <p> <b>RIDICAT</b></p> <p><b>Cand trebuie puse in aplicare masurile de control a riscurilor?</b> Inainte de utilizarea stivuitorului.</p>



125	<p><b>Pericol identificat:</b></p> <p><b>In cazul in care exista un risc, masurile propuse a fi puse in aplicare sunt:</b></p> <p>Exista un risc? DA <input checked="" type="checkbox"/> NU <input type="checkbox"/> Exista un control a riscurilor posibile? DA <input checked="" type="checkbox"/> NU <input type="checkbox"/></p> <p>Nivel risc:</p> <p> <b>RIDICAT</b></p> <p><b>Cand trebuie puse in aplicare masurile de control a riscurilor?</b> Inainte de utilizarea stivuitorului.</p>
126	<p><b>Pericol identificat:</b></p> <p><b>In cazul in care exista un risc, masurile propuse a fi puse in aplicare sunt:</b></p> <p>Exista un risc? DA <input type="checkbox"/> NU <input checked="" type="checkbox"/> Exista un control a riscurilor posibile? DA <input checked="" type="checkbox"/> NU <input type="checkbox"/></p> <p>Nivel risc:</p> <p> <b>SCAZUT</b></p> <p><b>Cand trebuie puse in aplicare masurile de control a riscurilor?</b> Inainte de utilizarea stivuitorului.</p>







127	<p><b>Pericol identificat:</b></p> <p><b>In cazul in care exista un risc, masurile propuse a fi puse in aplicare sunt:</b></p> <p>Exista un risc? DA <input checked="" type="checkbox"/> NU <input type="checkbox"/> Exista un control a riscurilor posibile? DA <input checked="" type="checkbox"/> NU <input type="checkbox"/></p> <p>Nivel risc:</p> <p> <b>RIDICAT</b></p> <p><b>Cand trebuie puse in aplicare masurile de control a riscurilor?</b> Inainte de utilizarea stivuitorului.</p>
128	<p><b>Pericol identificat:</b></p> <p><b>In cazul in care exista un risc, masurile propuse a fi puse in aplicare sunt:</b></p> <p>Exista un risc? DA <input type="checkbox"/> NU <input checked="" type="checkbox"/> Exista un control a riscurilor posibile? DA <input checked="" type="checkbox"/> NU <input type="checkbox"/></p> <p>Nivel risc:</p> <p> <b>SCAZUT</b></p> <p><b>Cand trebuie puse in aplicare masurile de control a riscurilor?</b> Inainte de utilizarea stivuitorului.</p>



129	<p><b>Pericol identificat:</b></p> <p><b>In cazul in care exista un risc, masurile propuse a fi puse in aplicare sunt:</b></p> <p>Exista un risc? DA <input checked="" type="checkbox"/> NU <input type="checkbox"/> Exista un control a riscurilor posibile? DA <input checked="" type="checkbox"/> NU <input type="checkbox"/></p> <p>Nivel risc:</p> <p> <b>RIDICAT</b></p> <p><b>Cand trebuie puse in aplicare masurile de control a riscurilor?</b> Inainte de utilizarea stivuitorului.</p>
130	<p><b>Pericol identificat:</b></p> <p><b>In cazul in care exista un risc, masurile propuse a fi puse in aplicare sunt:</b></p> <p>Exista un risc? DA <input checked="" type="checkbox"/> NU <input type="checkbox"/> Exista un control a riscurilor posibile? DA <input checked="" type="checkbox"/> NU <input type="checkbox"/></p> <p>Nivel risc:</p> <p> <b>RIDICAT</b></p> <p><b>Cand trebuie puse in aplicare masurile de control a riscurilor?</b> Inainte de utilizarea stivuitorului.</p>



131	<p><b>Pericol identificat:</b></p> <p><b>In cazul in care exista un risc, masurile propuse a fi puse in aplicare sunt:</b></p> <p>Exista un risc? DA <input checked="" type="checkbox"/> NU <input type="checkbox"/> Exista un control a riscurilor posibile? DA <input checked="" type="checkbox"/> NU <input type="checkbox"/></p> <p>Nivel risc:</p> <p> <b>RIDICAT</b></p> <p><b>Cand trebuie puse in aplicare masurile de control a riscurilor?</b> Inainte de utilizarea stivuitorului.</p>
132	<p><b>Pericol identificat:</b></p> <p><b>In cazul in care exista un risc, masurile propuse a fi puse in aplicare sunt:</b></p> <p>Exista un risc? DA <input checked="" type="checkbox"/> NU <input type="checkbox"/> Exista un control a riscurilor posibile? DA <input checked="" type="checkbox"/> NU <input type="checkbox"/></p> <p>Nivel risc:</p> <p> <b>RIDICAT</b></p> <p><b>Cand trebuie puse in aplicare masurile de control a riscurilor?</b> Inainte de utilizarea stivuitorului.</p>

133	<p><b>Pericol identificat:</b></p> <p><b>In cazul in care exista un risc, masurile propuse a fi puse in aplicare sunt:</b></p> <p>Exista un risc? DA <input checked="" type="checkbox"/> NU <input type="checkbox"/> Exista un control a riscurilor posibile? DA <input checked="" type="checkbox"/> NU <input type="checkbox"/></p> <p>Nivel risc:</p> <p> <b>RIDICAT</b></p> <p><b>Cand trebuie puse in aplicare masurile de control a riscurilor?</b> Inainte de utilizarea stivuitorului.</p>
134	<p><b>Pericol identificat:</b></p> <p><b>In cazul in care exista un risc, masurile propuse a fi puse in aplicare sunt:</b></p> <p>Exista un risc? DA <input checked="" type="checkbox"/> NU <input type="checkbox"/> Exista un control a riscurilor posibile? DA <input checked="" type="checkbox"/> NU <input type="checkbox"/></p> <p>Nivel risc:</p> <p> <b>RIDICAT</b></p> <p><b>Cand trebuie puse in aplicare masurile de control a riscurilor?</b> Inainte de utilizarea stivuitorului.</p>



135	<p><b>Pericol identificat:</b></p> <p><b>In cazul in care exista un risc, masurile propuse a fi puse in aplicare sunt:</b></p> <p>Exista un risc? DA <input checked="" type="checkbox"/> NU <input type="checkbox"/> Exista un control a riscurilor posibile? DA <input checked="" type="checkbox"/> NU <input type="checkbox"/></p> <p>Nivel risc:</p> <p> <b>RIDICAT</b></p> <p><b>Cand trebuie puse in aplicare masurile de control a riscurilor?</b> Inainte de utilizarea stivuitorului.</p>
136	<p><b>Pericol identificat:</b></p> <p><b>In cazul in care exista un risc, masurile propuse a fi puse in aplicare sunt:</b></p> <p>Exista un risc? DA <input checked="" type="checkbox"/> NU <input type="checkbox"/> Exista un control a riscurilor posibile? DA <input checked="" type="checkbox"/> NU <input type="checkbox"/></p> <p>Nivel risc:</p> <p> <b>RIDICAT</b></p> <p><b>Cand trebuie puse in aplicare masurile de control a riscurilor?</b> Inainte de utilizarea stivuitorului.</p>



137	<p><b>Pericol identificat:</b></p> <p><b>In cazul in care exista un risc, masurile propuse a fi puse in aplicare sunt:</b></p> <p>Exista un risc? DA <input checked="" type="checkbox"/> NU <input type="checkbox"/> Exista un control a riscurilor posibile? DA <input checked="" type="checkbox"/> NU <input type="checkbox"/></p> <p>Nivel risc:</p> <p> <b>RIDICAT</b></p> <p><b>Cand trebuie puse in aplicare masurile de control a riscurilor?</b> Inainte de utilizarea stivuitorului.</p>
138	<p><b>Pericol identificat:</b></p> <p><b>In cazul in care exista un risc, masurile propuse a fi puse in aplicare sunt:</b></p> <p>Exista un risc? DA <input checked="" type="checkbox"/> NU <input type="checkbox"/> Exista un control a riscurilor posibile? DA <input checked="" type="checkbox"/> NU <input type="checkbox"/></p> <p>Nivel risc:</p> <p> <b>RIDICAT</b></p> <p><b>Cand trebuie puse in aplicare masurile de control a riscurilor?</b> Inainte de utilizarea stivuitorului.</p>



139	<p><b>Pericol identificat:</b></p> <p><b>In cazul in care exista un risc, masurile propuse a fi puse in aplicare sunt:</b></p> <p>Exista un risc? DA <input checked="" type="checkbox"/> NU <input type="checkbox"/> Exista un control a riscurilor posibile? DA <input checked="" type="checkbox"/> NU <input type="checkbox"/></p> <p>Nivel risc:</p> <p> <b>RIDICAT</b></p> <p><b>Cand trebuie puse in aplicare masurile de control a riscurilor?</b> Inainte de utilizarea stivuitorului.</p>
140	<p><b>Pericol identificat:</b></p> <p><b>In cazul in care exista un risc, masurile propuse a fi puse in aplicare sunt:</b></p> <p>Exista un risc? DA <input checked="" type="checkbox"/> NU <input type="checkbox"/> Exista un control a riscurilor posibile? DA <input checked="" type="checkbox"/> NU <input type="checkbox"/></p> <p>Nivel risc:</p> <p> <b>RIDICAT</b></p> <p><b>Cand trebuie puse in aplicare masurile de control a riscurilor?</b> Inainte de utilizarea stivuitorului.</p>



141	<p><b>Pericol identificat:</b></p> <p><b>In cazul in care exista un risc, masurile propuse a fi puse in aplicare sunt:</b></p> <p>Exista un risc? DA <input checked="" type="checkbox"/> NU <input type="checkbox"/> Exista un control a riscurilor posibile? DA <input checked="" type="checkbox"/> NU <input type="checkbox"/></p> <p>Nivel risc:</p> <p> <b>MEDIU</b></p> <p><b>Cand trebuie puse in aplicare masurile de control a riscurilor?</b> Inainte de utilizarea stivuitorului.</p>
142	<p><b>Pericol identificat:</b></p> <p><b>In cazul in care exista un risc, masurile propuse a fi puse in aplicare sunt:</b></p> <p>Exista un risc? DA <input checked="" type="checkbox"/> NU <input type="checkbox"/> Exista un control a riscurilor posibile? DA <input checked="" type="checkbox"/> NU <input type="checkbox"/></p> <p>Nivel risc:</p> <p> <b>RIDICAT</b></p> <p><b>Cand trebuie puse in aplicare masurile de control a riscurilor?</b> Inainte de utilizarea stivuitorului.</p>







143	<p><b>Pericol identificat:</b></p> <p><b>In cazul in care exista un risc, masurile propuse a fi puse in aplicare sunt:</b></p> <p>Exista un risc? DA <input checked="" type="checkbox"/> NU <input type="checkbox"/> Exista un control a riscurilor posibile? DA <input checked="" type="checkbox"/> NU <input type="checkbox"/></p> <p>Nivel risc:</p> <p> <b>RIDICAT</b></p> <p><b>Cand trebuie puse in aplicare masurile de control a riscurilor?</b> Inainte de utilizarea stivuitorului.</p>
144	<p><b>Pericol identificat:</b></p> <p><b>In cazul in care exista un risc, masurile propuse a fi puse in aplicare sunt:</b></p> <p>Exista un risc? DA <input checked="" type="checkbox"/> NU <input type="checkbox"/> Exista un control a riscurilor posibile? DA <input checked="" type="checkbox"/> NU <input type="checkbox"/></p> <p>Nivel risc:</p> <p> <b>RIDICAT</b></p> <p><b>Cand trebuie puse in aplicare masurile de control a riscurilor?</b> Inainte de utilizarea stivuitorului.</p>



145	<p><b>Pericol identificat:</b></p> <p><b>In cazul in care exista un risc, masurile propuse a fi puse in aplicare sunt:</b></p> <p>Exista un risc? DA <input type="checkbox"/> NU <input checked="" type="checkbox"/> Exista un control a riscurilor posibile? DA <input checked="" type="checkbox"/> NU <input type="checkbox"/></p> <p>Nivel risc:</p> <p> SCAZUT</p> <p><b>Cand trebuie puse in aplicare masurile de control a riscurilor?</b> Inainte de utilizarea stivuitorului.</p>
146	<p><b>Pericol identificat:</b></p> <p><b>In cazul in care exista un risc, masurile propuse a fi puse in aplicare sunt:</b></p> <p>Exista un risc? DA <input checked="" type="checkbox"/> NU <input type="checkbox"/> Exista un control a riscurilor posibile? DA <input checked="" type="checkbox"/> NU <input type="checkbox"/></p> <p>Nivel risc:</p> <p> RIDICAT</p> <p><b>Cand trebuie puse in aplicare masurile de control a riscurilor?</b> Inainte de utilizarea stivuitorului.</p>

147	<p><b>Pericol identificat:</b></p> <p><b>In cazul in care exista un risc, masurile propuse a fi puse in aplicare sunt:</b></p> <p>Exista un risc? DA <input checked="" type="checkbox"/> NU <input type="checkbox"/> Exista un control a riscurilor posibile? DA <input checked="" type="checkbox"/> NU <input type="checkbox"/></p> <p>Nivel risc:</p> <p> <b>RIDICAT</b></p> <p><b>Cand trebuie puse in aplicare masurile de control a riscurilor?</b> Inainte de utilizarea stivuitorului.</p>
148	<p><b>Pericol identificat:</b></p> <p><b>In cazul in care exista un risc, masurile propuse a fi puse in aplicare sunt:</b></p> <p>Exista un risc? DA <input type="checkbox"/> NU <input checked="" type="checkbox"/> Exista un control a riscurilor posibile? DA <input checked="" type="checkbox"/> NU <input type="checkbox"/></p> <p>Nivel risc:</p> <p> <b>SCAZUT</b></p> <p><b>Cand trebuie puse in aplicare masurile de control a riscurilor?</b> Inainte de utilizarea stivuitorului.</p>

149	<p><b>Pericol identificat:</b></p> <p><b>In cazul in care exista un risc, masurile propuse a fi puse in aplicare sunt:</b></p> <p>Exista un risc? DA <input checked="" type="checkbox"/> NU <input type="checkbox"/> Exista un control a riscurilor posibile? DA <input checked="" type="checkbox"/> NU <input type="checkbox"/></p> <p>Nivel risc:</p> <p> <b>RIDICAT</b></p> <p><b>Cand trebuie puse in aplicare masurile de control a riscurilor?</b> Inainte de utilizarea stivuitorului.</p>
150	<p><b>Pericol identificat:</b></p> <p><b>In cazul in care exista un risc, masurile propuse a fi puse in aplicare sunt:</b></p> <p>Exista un risc? DA <input checked="" type="checkbox"/> NU <input type="checkbox"/> Exista un control a riscurilor posibile? DA <input checked="" type="checkbox"/> NU <input type="checkbox"/></p> <p>Nivel risc:</p> <p> <b>RIDICAT</b></p> <p><b>Cand trebuie puse in aplicare masurile de control a riscurilor?</b> Inainte de utilizarea stivuitorului.</p>

151	<p><b>Pericol identificat:</b></p> <p><b>In cazul in care exista un risc, masurile propuse a fi puse in aplicare sunt:</b></p> <p>Exista un risc? DA <input checked="" type="checkbox"/> NU <input type="checkbox"/> Exista un control a riscurilor posibile? DA <input checked="" type="checkbox"/> NU <input type="checkbox"/></p> <p>Nivel risc:</p> <p> <b>RIDICAT</b></p> <p><b>Cand trebuie puse in aplicare masurile de control a riscurilor?</b> Inainte de utilizarea stivuitorului.</p>
152	<p><b>Pericol identificat:</b></p> <p><b>In cazul in care exista un risc, masurile propuse a fi puse in aplicare sunt:</b></p> <p>Exista un risc? DA <input checked="" type="checkbox"/> NU <input type="checkbox"/> Exista un control a riscurilor posibile? DA <input checked="" type="checkbox"/> NU <input type="checkbox"/></p> <p>Nivel risc:</p> <p> <b>RIDICAT</b></p> <p><b>Cand trebuie puse in aplicare masurile de control a riscurilor?</b> Inainte de utilizarea stivuitorului.</p>

153	<p><b>Pericol identificat:</b></p> <p><b>In cazul in care exista un risc, masurile propuse a fi puse in aplicare sunt:</b></p> <p>Exista un risc? DA <input checked="" type="checkbox"/> NU <input type="checkbox"/> Exista un control a riscurilor posibile? DA <input checked="" type="checkbox"/> NU <input type="checkbox"/></p> <p>Nivel risc:</p> <p> <b>RIDICAT</b></p> <p><b>Cand trebuie puse in aplicare masurile de control a riscurilor?</b> Inainte de utilizarea stivuitorului.</p>
154	<p><b>Pericol identificat:</b></p> <p><b>In cazul in care exista un risc, masurile propuse a fi puse in aplicare sunt:</b></p> <p>Exista un risc? DA <input checked="" type="checkbox"/> NU <input type="checkbox"/> Exista un control a riscurilor posibile? DA <input checked="" type="checkbox"/> NU <input type="checkbox"/></p> <p>Nivel risc:</p> <p> <b>RIDICAT</b></p> <p><b>Cand trebuie puse in aplicare masurile de control a riscurilor?</b> Inainte de utilizarea stivuitorului.</p>

155	<p><b>Pericol identificat:</b></p> <p style="text-align: right;"><b>In cazul in care exista un risc, masurile propuse a fi puse in aplicare sunt:</b></p> <p>Exista un risc? DA <input checked="" type="checkbox"/> NU <input type="checkbox"/> Exista un control a riscurilor posibile? DA <input checked="" type="checkbox"/> NU <input type="checkbox"/></p> <p>Nivel risc:</p> <p> <b>RIDICAT</b></p> <p><b>Cand trebuie puse in aplicare masurile de control a riscurilor?</b> Inainte de utilizarea stivuiitorului.</p>
156	<p><b>Pericol identificat:</b></p> <p style="text-align: right;"><b>In cazul in care exista un risc, masurile propuse a fi puse in aplicare sunt:</b></p> <p>Exista un risc? DA <input checked="" type="checkbox"/> NU <input type="checkbox"/> Exista un control a riscurilor posibile? DA <input checked="" type="checkbox"/> NU <input type="checkbox"/></p> <p>Nivel risc:</p> <p> <b>RIDICAT</b></p> <p><b>Cand trebuie puse in aplicare masurile de control a riscurilor?</b> Inainte de utilizarea stivuiitorului.</p>

157	<p><b>Pericol identificat:</b></p> <p><b>Persoane care pot fi ranite in cazul in care nu se cunoaste greutatea sarcinii care urmeaza sa fie ridicata cu ajutorul stivuitorului.</b></p> <p>Exista un risc? DA <input checked="" type="checkbox"/> NU <input type="checkbox"/></p> <p><b>Nivel risc:</b></p> <p> <b>RIDICAT</b></p>	<p><b>In cazul in care exista un risc, masurile propuse a fi puse in aplicare sunt:</b></p> <p>Trebuie sa va asigurati ca greutatea tuturor sarcinilor care urmeaza sa fie ridicate cu ajutorul stivuitorului este cunoscuta. Se va instrui stivuitorul sa nu ridice sarcini, a caror greutate nu este cunoscuta, cu ajutorul stivuitorului.</p> <p>Exista un control a riscurilor posibile? DA <input checked="" type="checkbox"/> NU <input type="checkbox"/></p> <p><b>Cand trebuie puse in aplicare masurile de control a riscurilor?</b></p> <p>Inainte de utilizarea stivuitorului.</p>
-----	---	---