

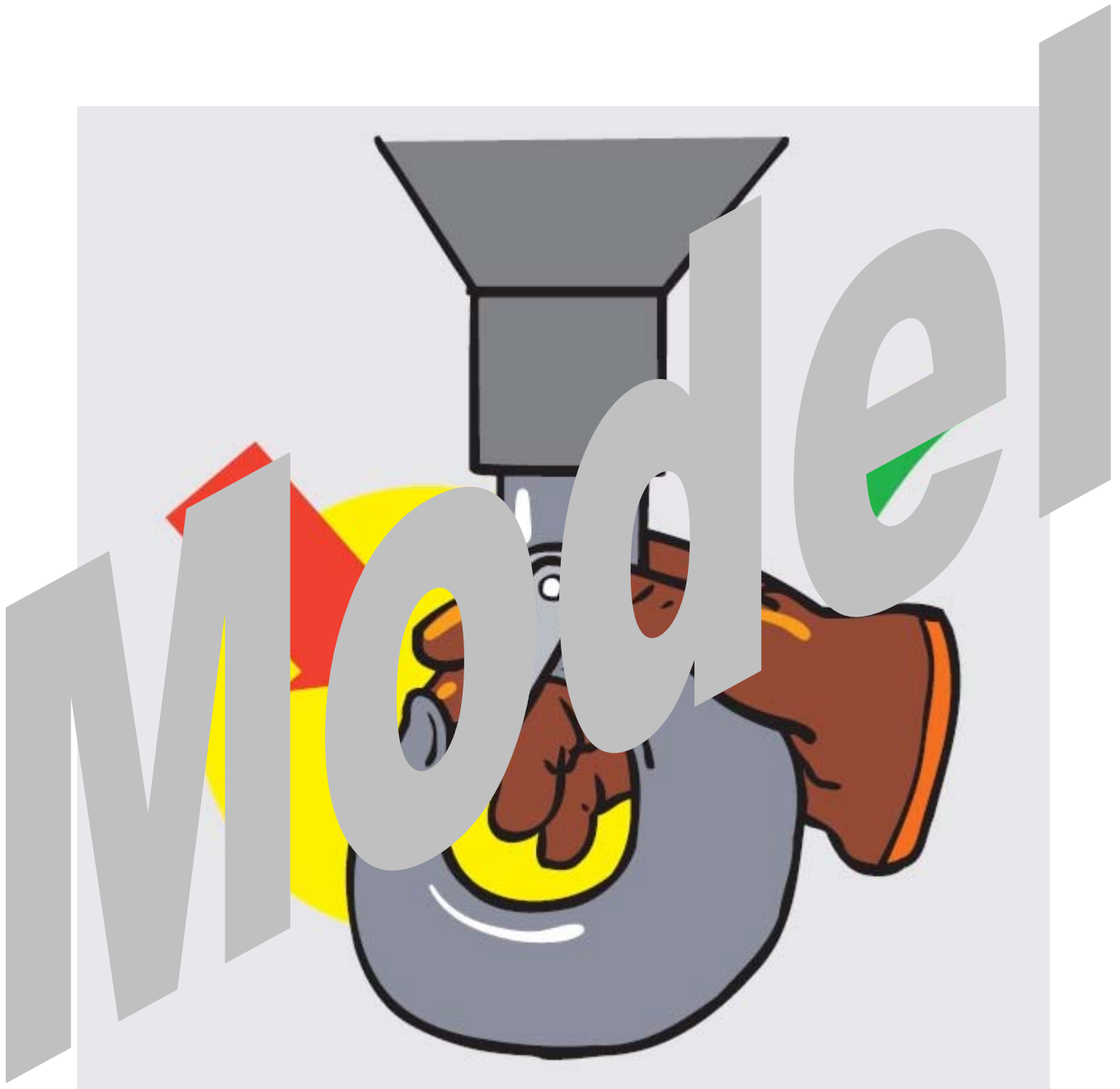

SC ASISCO TEHNIC SRL
str. Pietrele Doamnei nr. 25, cod postal 060317, sector 6, Bucuresti
telefon: 031 – 1043756
mobil: 0753 – 012324
e-mail: office@asisco.ro
http://www.asisco.ro

RC : J40/15649/2007
CUI : RO 22280483
Cont IBAN: RO11FNNB005402576399RO02
Banca: Credit Europe Bank – Crangasi

Instructiuni prindere sarcina





SC ASISCO TEHNIC SRL
str. Pietrele Doamnei nr. 25, cod postal 060317, sector 6, Bucuresti
telefon: 031 – 1043756
mobil: 0753 – 012324
e-mail: office@asisco.ro
http://www.asisco.ro

RC : J40/15649/2007
CUI : RO 22280483
Cont IBAN: RO11FNNB005402576399RO02
Banca: Credit Europe Bank – Crangasi

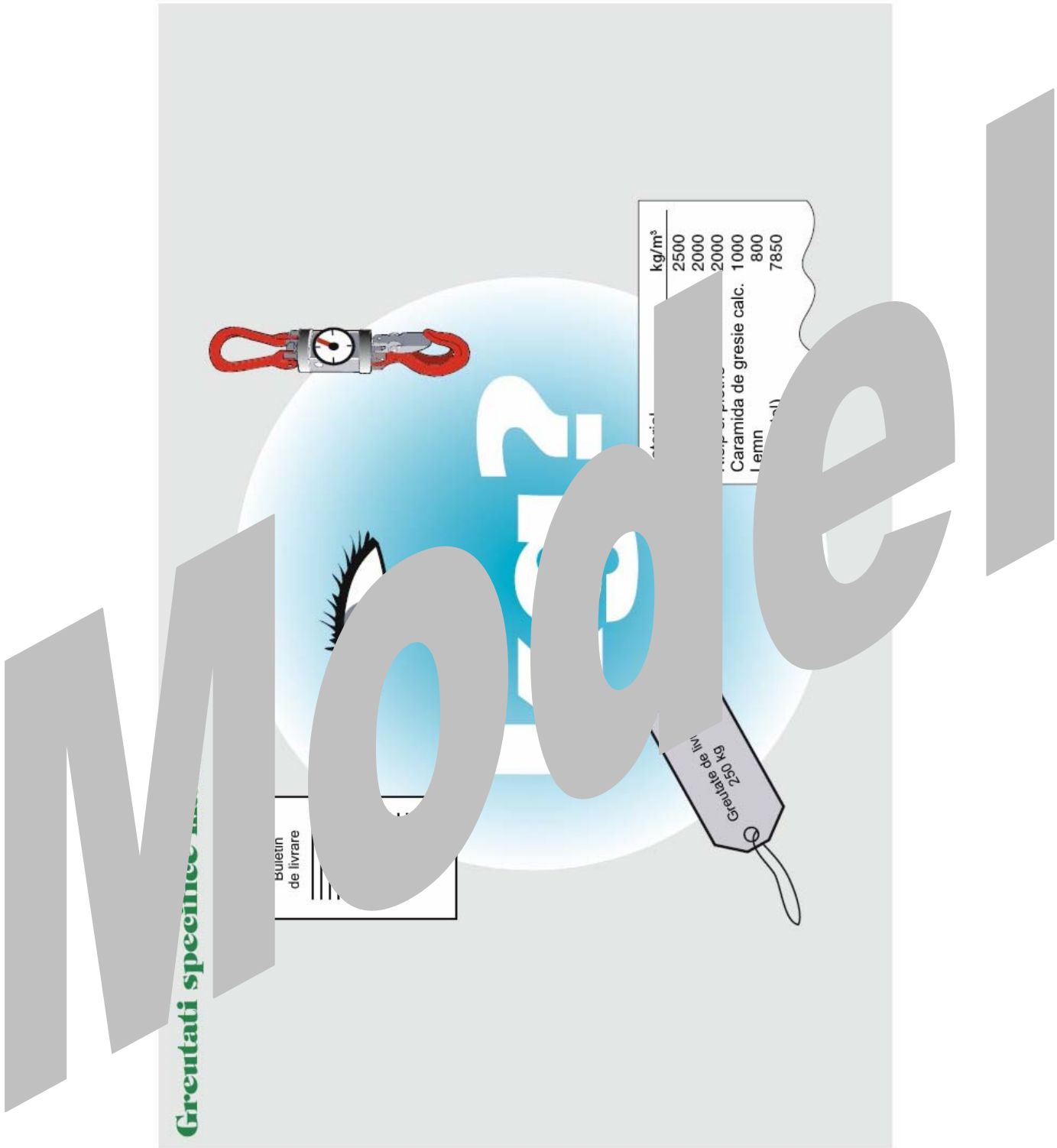

kg/m³
2500
2000
2000
Caramida de gresie calc. 1000
Lemn (m³)
800
7850

buletin
de livrare

Greutate de livr
250 Kg



SC ASISCO TEHNIC SRL
str. Pietrele Doamnei nr. 25, cod postal 060317, sector 6, Bucuresti
telefon: 031 – 1043756
mobil: 0753 – 012324
e-mail: office@asisco.ro
http://www.asisco.ro

RC : J40/15649/2007
CUI : RO 22280483
Cont IBAN: RO11FNNB005402576399RO02
Banca: Credit Europe Bank – Crangasi

Creșterea unghiului de inclinare
scade greutatea sarcinii ridicate!

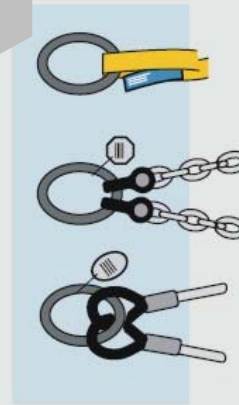
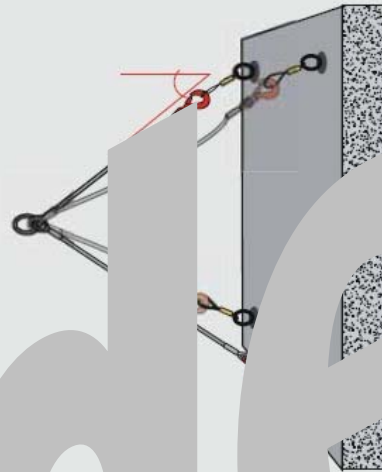
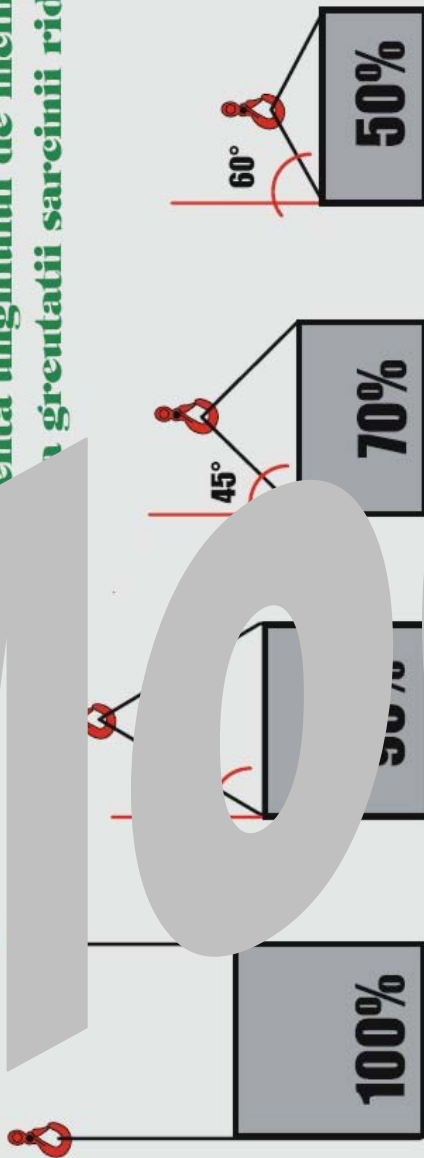



SC ASISCO TEHNIC SRL
str. Pietrele Doamnei nr. 25, cod postal 060317, sector 6, Bucuresti
telefon: 031 – 1043756
mobil: 0753 – 012324
e-mail: office@asisco.ro
http://www.asisco.ro

RC : J40/15649/2007
CUI : RO 22280483
Cont IBAN: RO11FNNB005402576399RO02
Banca: Credit Europe Bank – Crangasi





SC ASISCO TEHNIC SRL
str. Pietrele Doamnei nr. 25, cod postal 060317, sector 6, Bucuresti
telefon: 031 – 1043756
mobil: 0753 – 012324
e-mail: office@asisco.ro
http://www.asisco.ro

RC : J40/15649/2007
CUI : RO 22280483
Cont IBAN: RO11FNNB005402576399RO02
Banca: Credit Europe Bank – Crangasi



Modaliitate de procesare

4



SC ASISCO TEHNIC SRL
str. Pietrele Doamnei nr. 25, cod postal 060317, sector 6, Bucuresti
telefon: 031 – 1043756
mobil: 0753 – 012324
e-mail: office@asisco.ro
http://www.asisco.ro

RC : J40/15649/2007
CUI : RO 22280483
Cont IBAN: RO11FNNB005402576399RO02
Banca: Credit Europe Bank – Crangasi

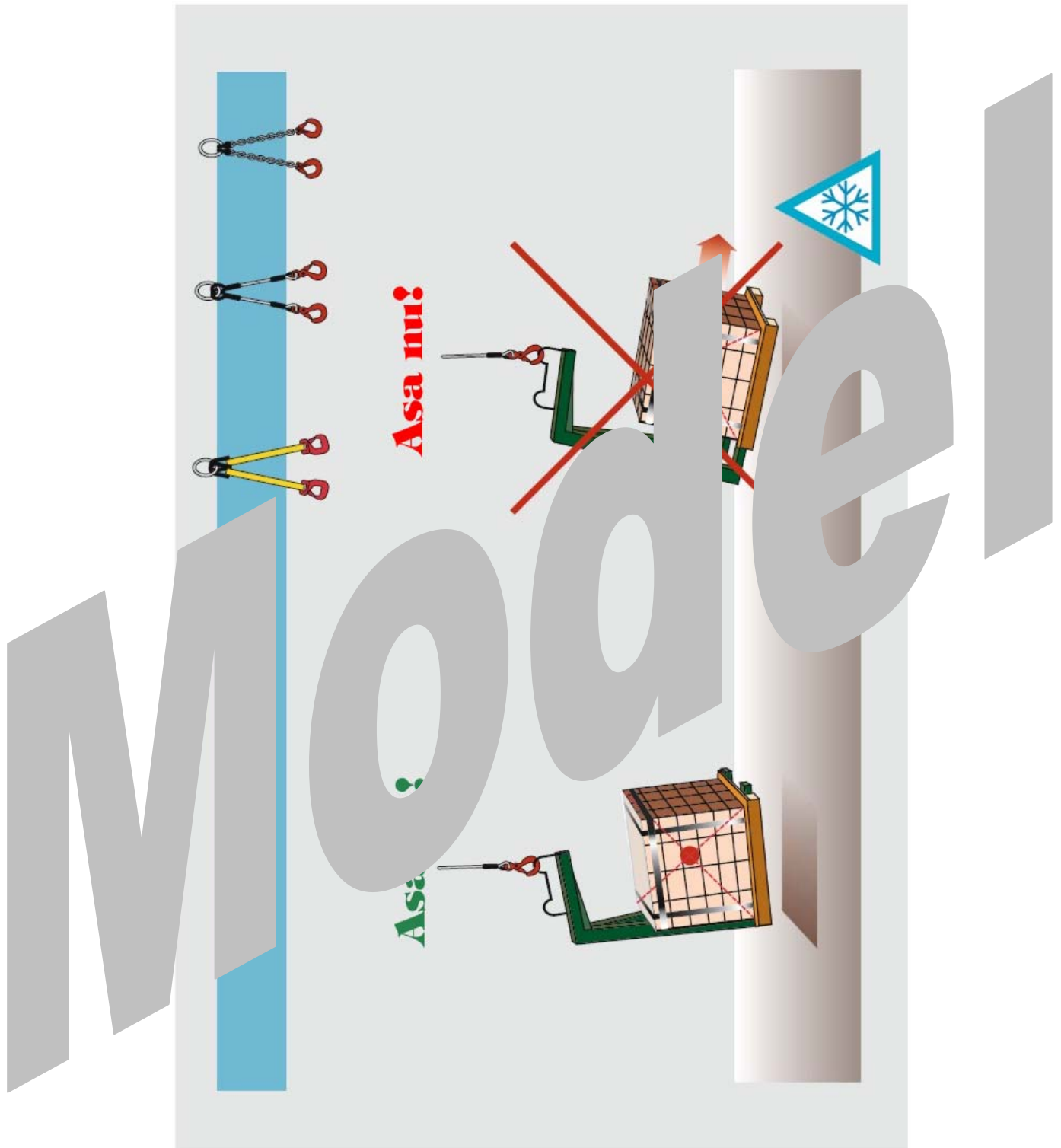



SC ASISCO TEHNIC SRL
str. Pietrele Doamnei nr. 25, cod postal 060317, sector 6, Bucuresti
telefon: 031 – 1043756
mobil: 0753 – 012324
e-mail: office@asisco.ro
http://www.asisco.ro

RC : J40/15649/2007
CUI : RO 22280483
Cont IBAN: RO11FNNB005402576399RO02
Banca: Credit Europe Bank – Crangasi

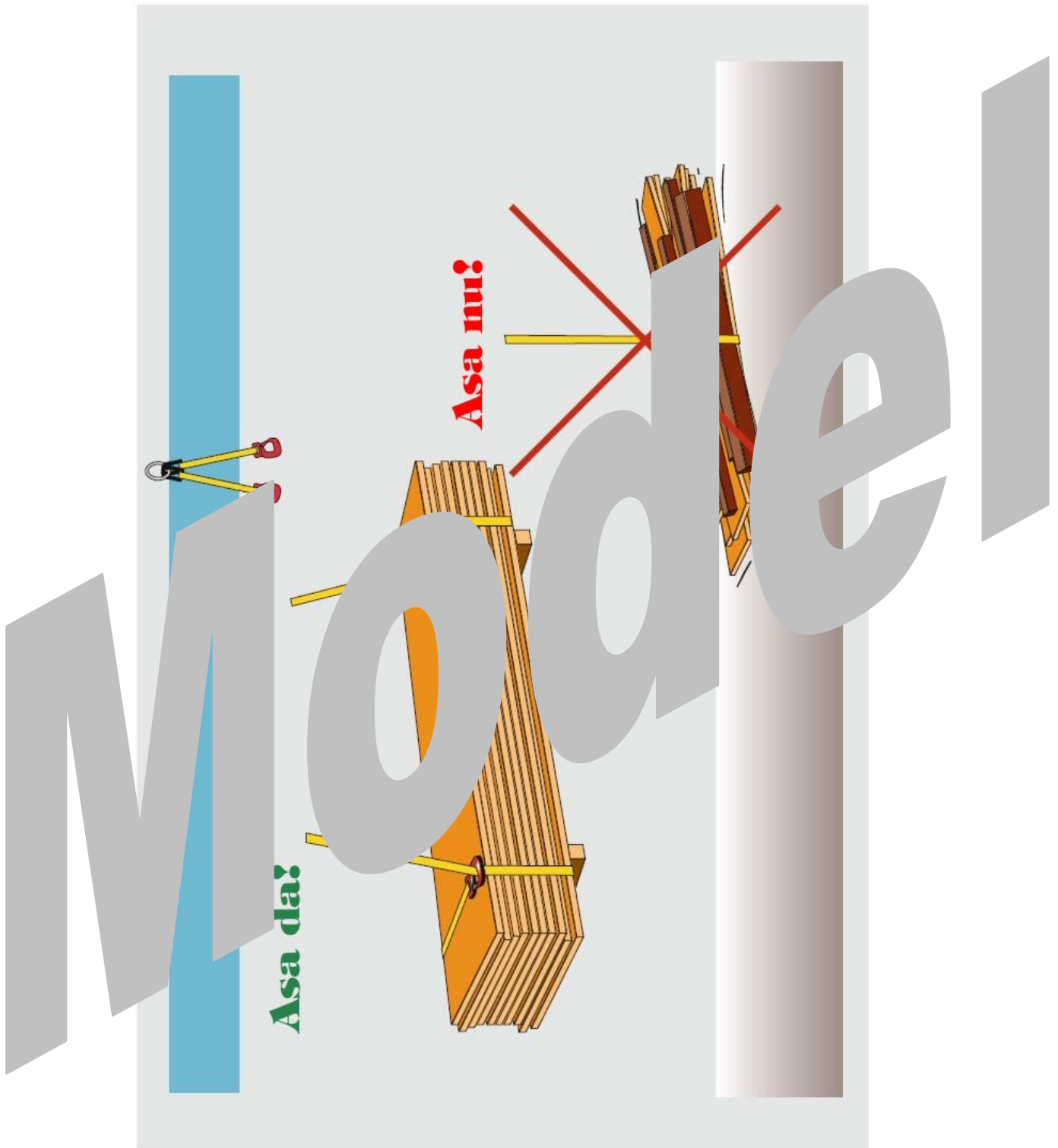



SC ASISCO TEHNIC SRL
str. Pietrele Doamnei nr. 25, cod postal 060317, sector 6, Bucuresti
telefon: 031 – 1043756
mobil: 0753 – 012324
e-mail: office@asisco.ro
http://www.asisco.ro

RC : J40/15649/2007
CUI : RO 22280483
Cont IBAN: RO11FNNB005402576399RO02
Banca: Credit Europe Bank – Crangasi

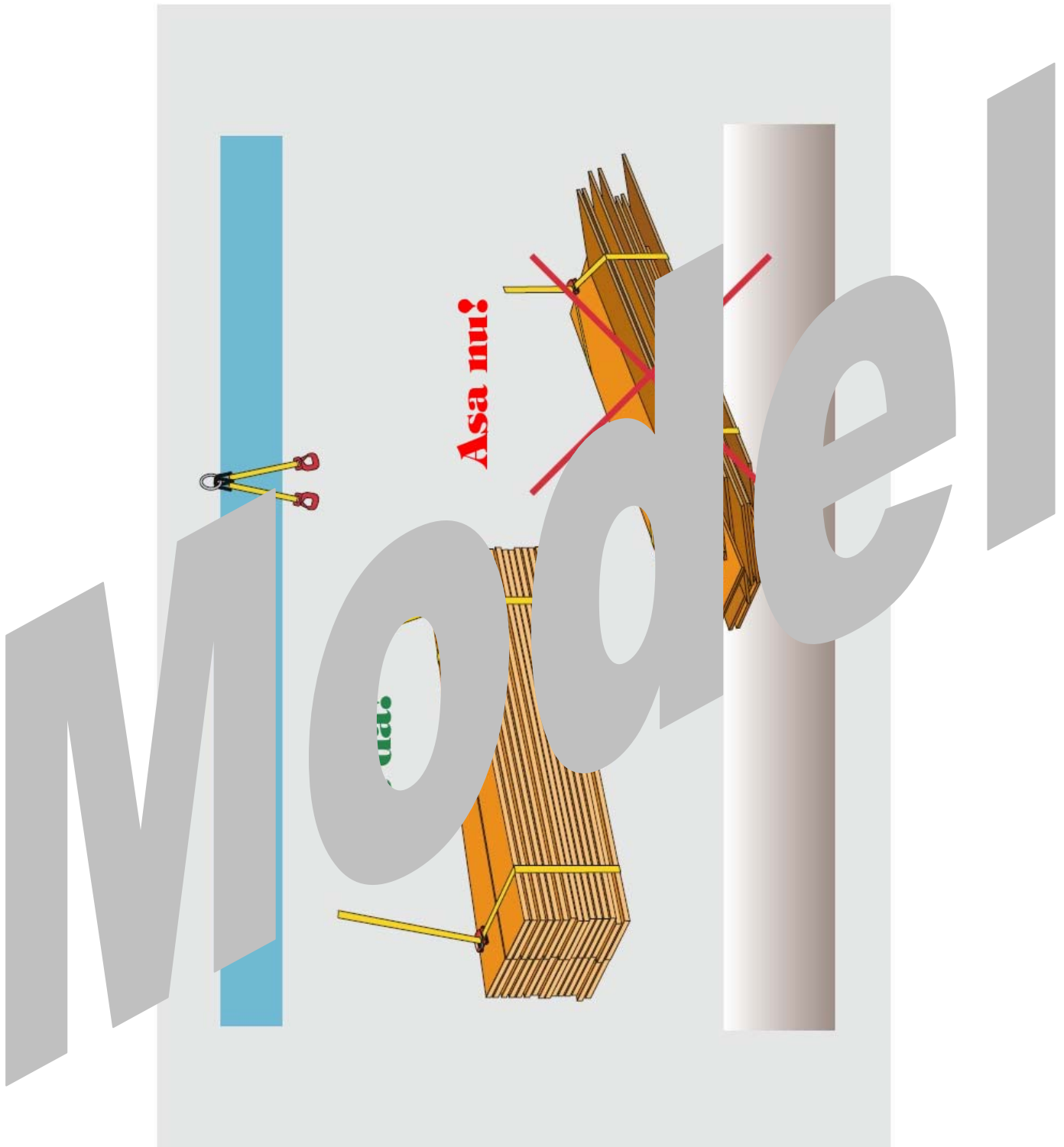

7



SC ASISCO TEHNIC SRL
str. Pietrele Doamnei nr. 25, cod postal 060317, sector 6, Bucuresti
telefon: 031 – 1043756
mobil: 0753 – 012324
e-mail: office@asisco.ro
http://www.asisco.ro

RC : J40/15649/2007
CUI : RO 22280483
Cont IBAN: RO11FNNB005402576399RO02
Banca: Credit Europe Bank – Crangasi

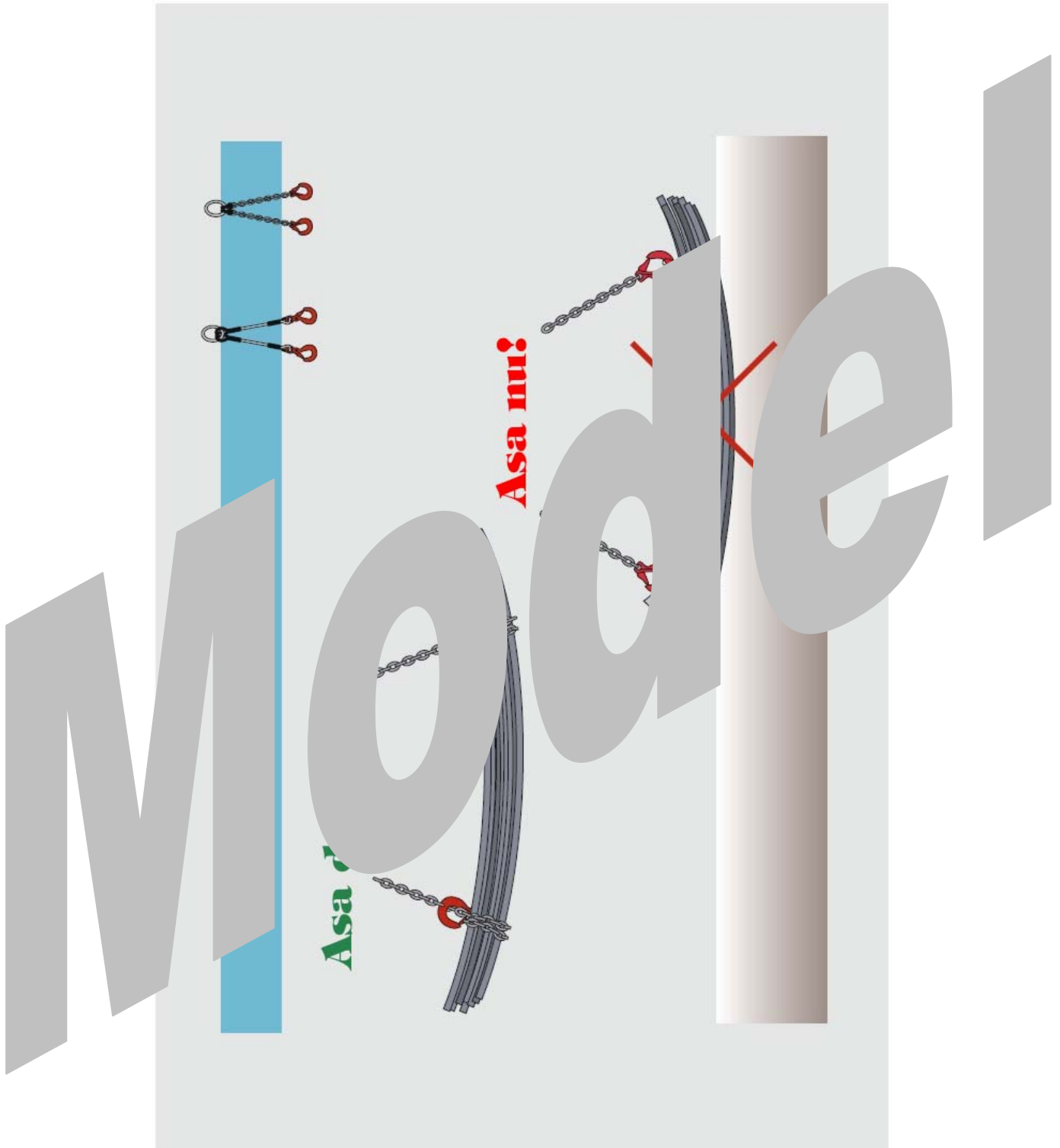



SC ASISCO TEHNIC SRL
str. Pietrele Doamnei nr. 25, cod postal 060317, sector 6, Bucuresti
telefon: 031 – 1043756
mobil: 0753 – 012324
e-mail: office@asisco.ro
http://www.asisco.ro

RC : J40/15649/2007
CUI : RO 22280483
Cont IBAN: RO11FNNB005402576399RO02
Banca: Credit Europe Bank – Crangasi

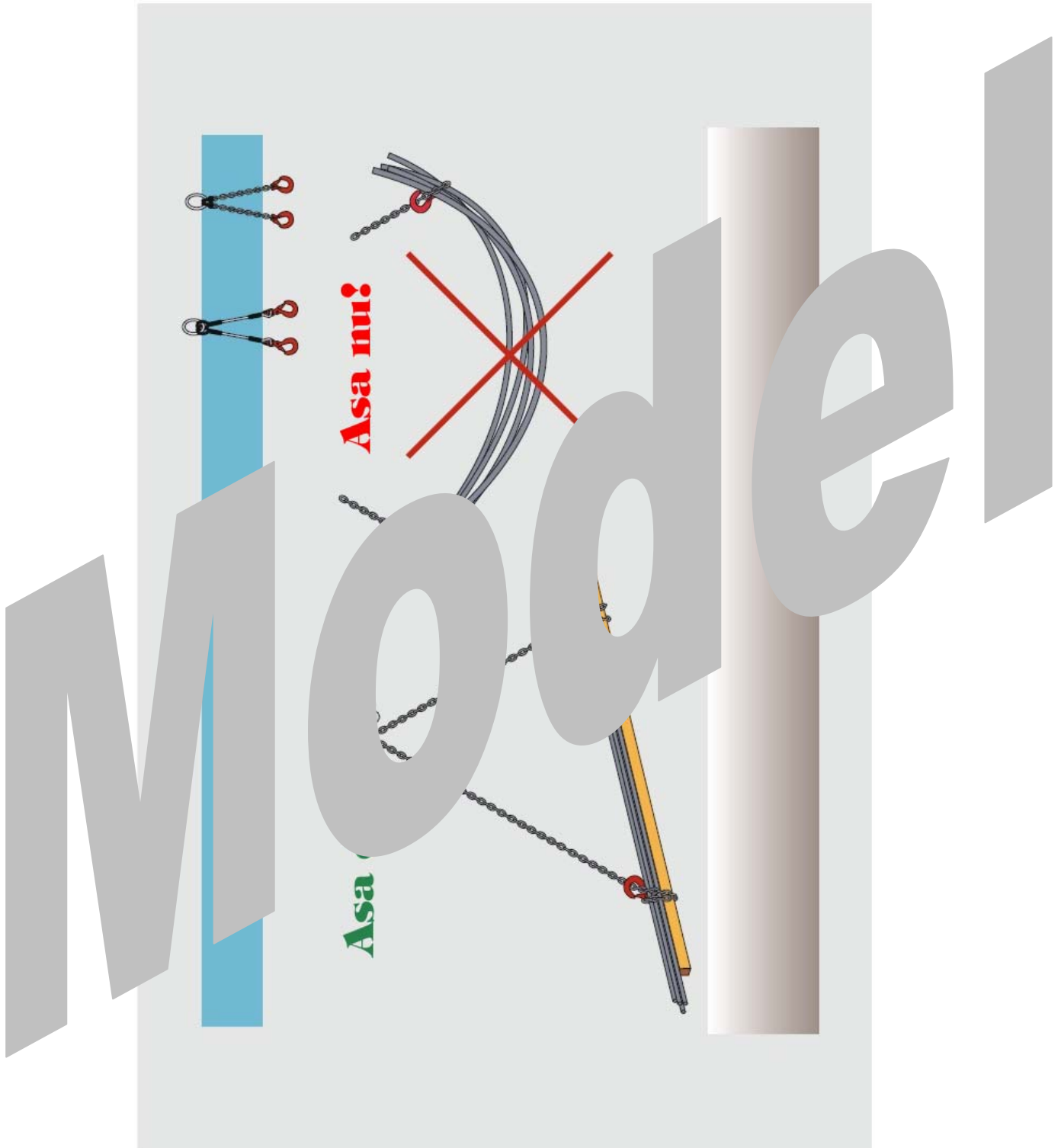



SC ASISCO TEHNIC SRL
str. Pietrele Doamnei nr. 25, cod postal 060317, sector 6, Bucuresti
telefon: 031 – 1043756
mobil: 0753 – 012324
e-mail: office@asisco.ro
http://www.asisco.ro

RC : J40/15649/2007
CUI : RO 22280483
Cont IBAN: RO11FNNB005402576399RO02
Banca: Credit Europe Bank – Crangasi

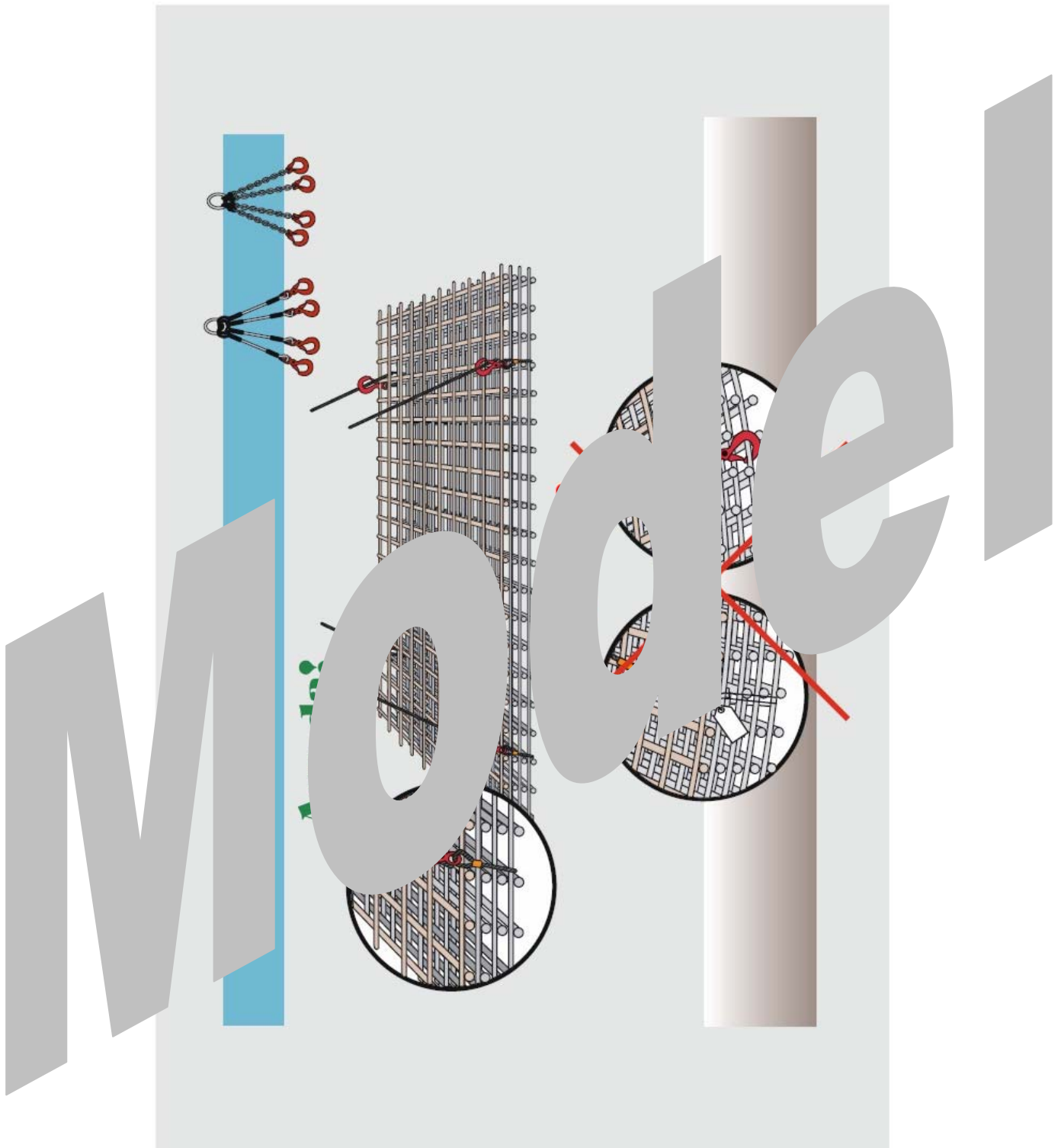



SC ASISCO TEHNIC SRL
str. Pietrele Doamnei nr. 25, cod postal 060317, sector 6, Bucuresti
telefon: 031 – 1043756
mobil: 0753 – 012324
e-mail: office@asisco.ro
http://www.asisco.ro

RC : J40/15649/2007
CUI : RO 22280483
Cont IBAN: RO11FNNB005402576399RO02
Banca: Credit Europe Bank – Crangasi

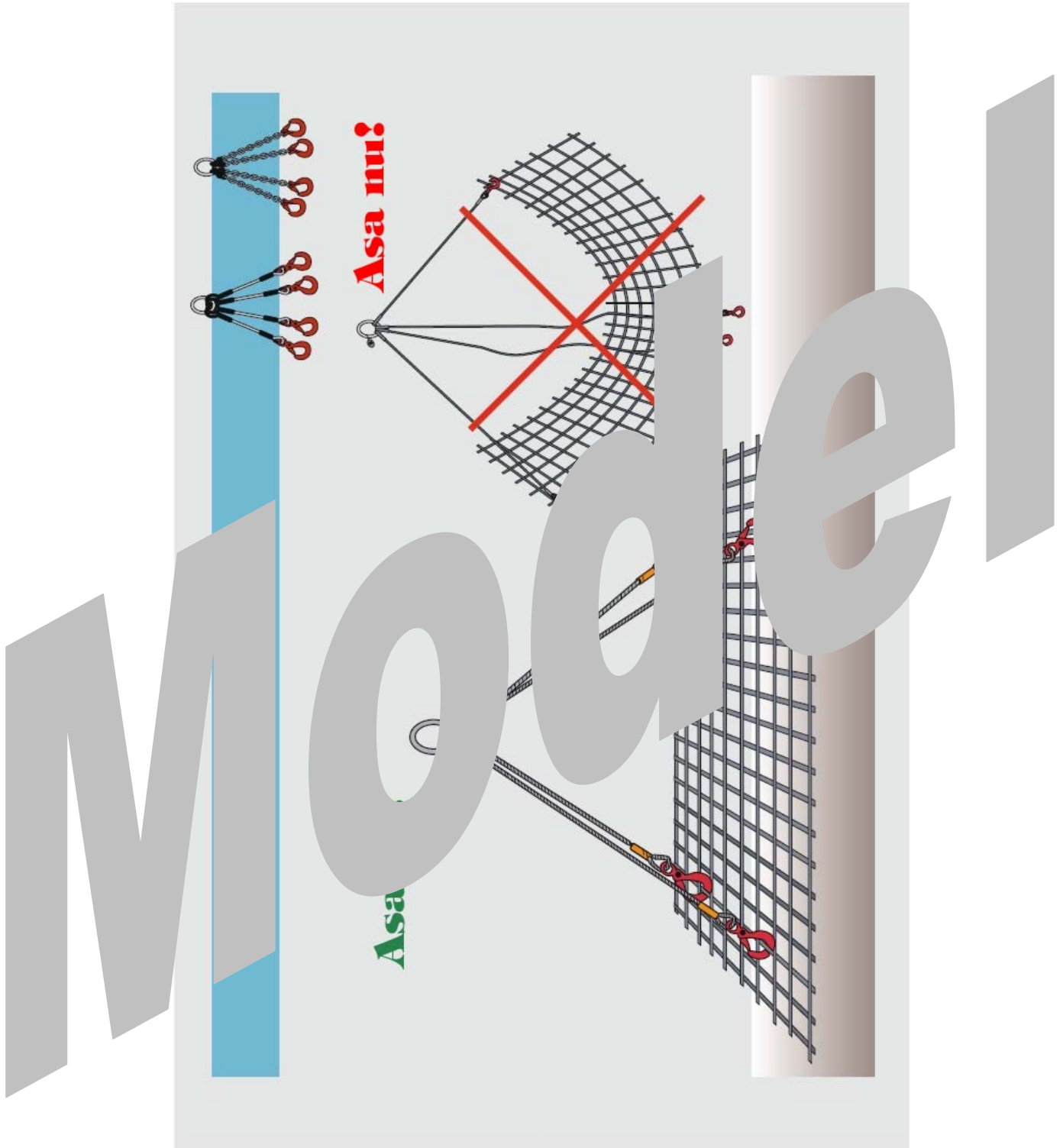



SC ASISCO TEHNIC SRL
str. Pietrele Doamnei nr. 25, cod postal 060317, sector 6, Bucuresti
telefon: 031 – 1043756
mobil: 0753 – 012324
e-mail: office@asisco.ro
http://www.asisco.ro

RC : J40/15649/2007
CUI : RO 22280483
Cont IBAN: RO11FNNB005402576399RO02
Banca: Credit Europe Bank – Crangasi

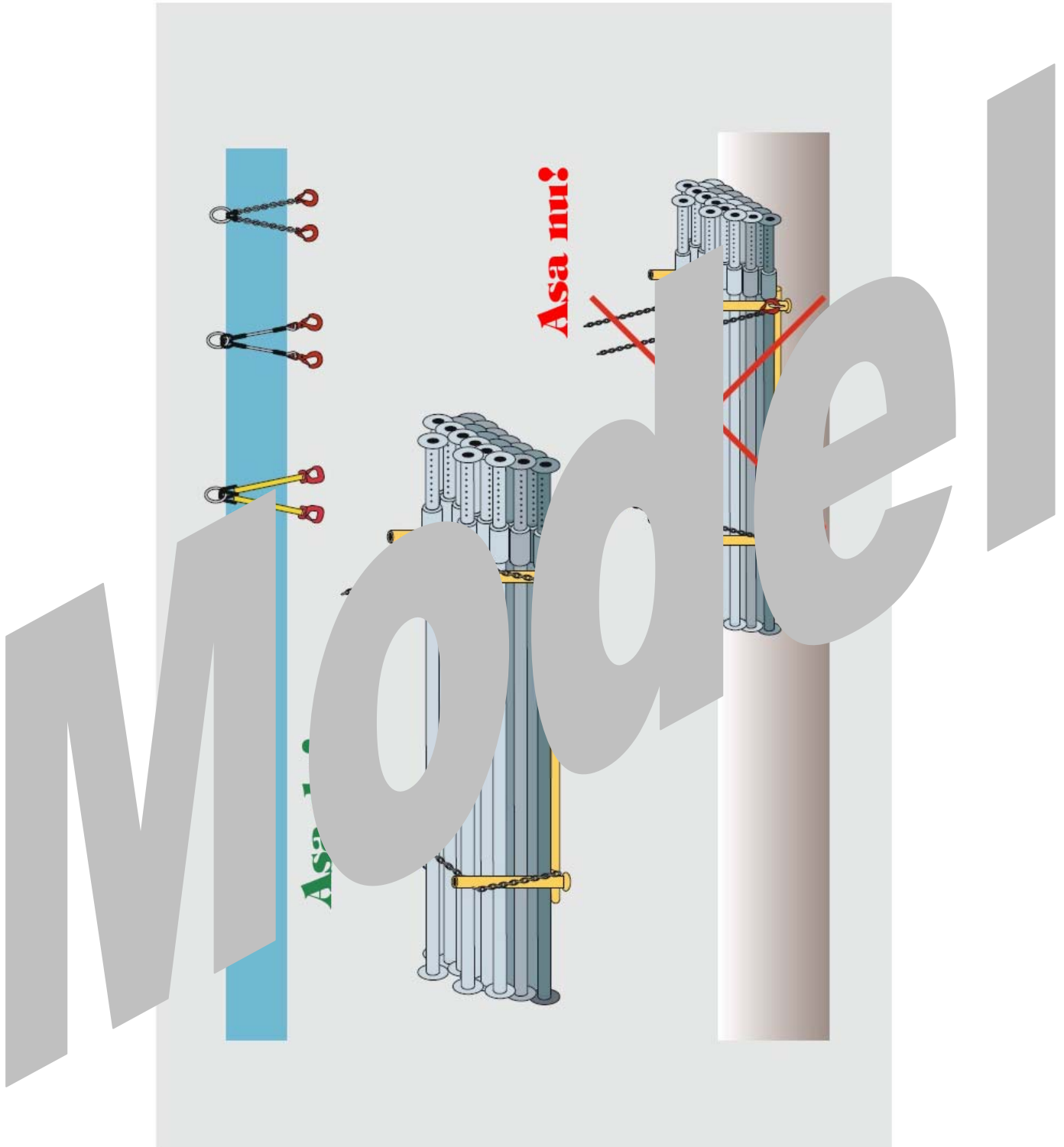



SC ASISCO TEHNIC SRL
str. Pietrele Doamnei nr. 25, cod postal 060317, sector 6, Bucuresti
telefon: 031 – 1043756
mobil: 0753 – 012324
e-mail: office@asisco.ro
http://www.asisco.ro

RC : J40/15649/2007
CUI : RO 22280483
Cont IBAN: RO11FNNB005402576399RO02
Banca: Credit Europe Bank – Crangasi

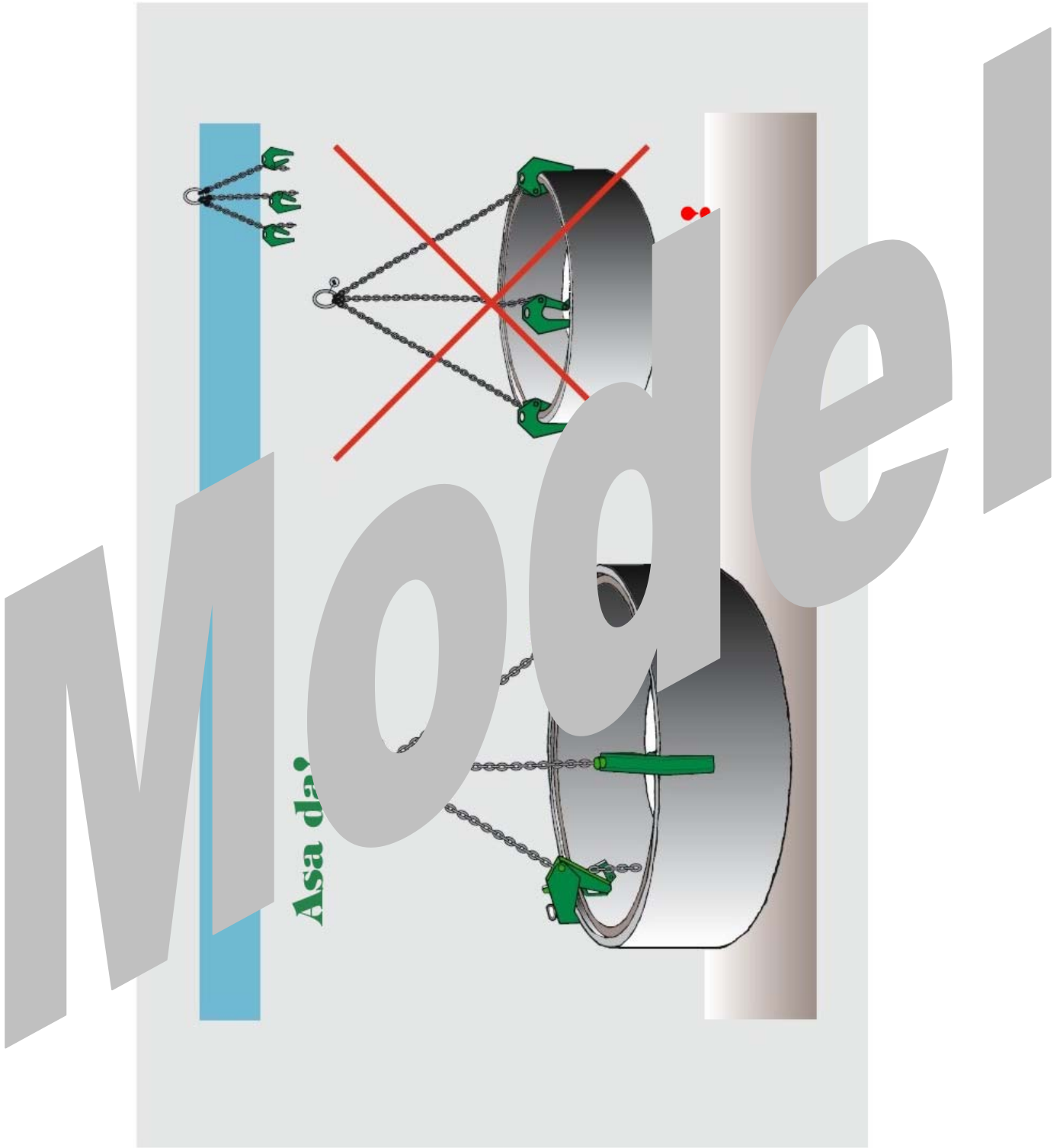



SC ASISCO TEHNIC SRL
str. Pietrele Doamnei nr. 25, cod postal 060317, sector 6, Bucuresti
telefon: 031 – 1043756
mobil: 0753 – 012324
e-mail: office@asisco.ro
http://www.asisco.ro

RC : J40/15649/2007
CUI : RO 22280483
Cont IBAN: RO11FNNB005402576399RO02
Banca: Credit Europe Bank – Crangasi

